

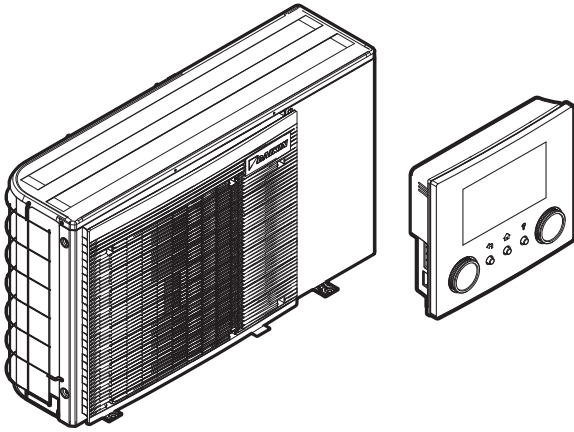

Installer reference guide

Packaged air-cooled water chillers and packaged air to water heat pumps



<https://daikintechnicaldatahub.eu>



EWAA004D2V3P
EWAA006D2V3P
EWAA008D2V3P
EWAA004D2V3P-H
EWAA006D2V3P-H
EWAA008D2V3P-H

EWYA004D2V3P
EWYA006D2V3P
EWYA008D2V3P
EWYA004D2V3P-H
EWYA006D2V3P-H
EWYA008D2V3P-H

Table of contents

1	About this document	5
1.1	Meaning of warnings and symbols	6
1.2	Installer reference guide at a glance	7
2	General safety precautions	9
2.1	For the installer	9
2.1.1	General	9
2.1.2	Installation site	10
2.1.3	Refrigerant — in case of R410A or R32	10
2.1.4	Water	12
2.1.5	Electrical	12
3	Specific installer safety instructions	15
4	About the box	18
4.1	Outdoor unit	18
4.1.1	To unpack the outdoor unit	18
4.1.2	To remove the accessories from the outdoor unit	18
5	About the units and options	20
5.1	Identification	20
5.1.1	Identification label: Outdoor unit	20
5.2	Combining units and options	21
5.2.1	Possible options for the outdoor unit	21
6	Application guidelines	24
6.1	Overview: Application guidelines	24
6.2	Setting up the space heating/cooling system	25
6.2.1	Single room	26
6.2.2	Multiple rooms – One LWT zone	30
6.2.3	Multiple rooms – Two LWT zones	33
6.3	Setting up an auxiliary heat source for space heating	36
6.4	Setting up the energy metering	39
6.4.1	Produced heat	39
6.4.2	Consumed energy	40
6.4.3	Power supply layouts with power meters	40
6.5	Setting up the power consumption control	43
6.5.1	Permanent power limitation	44
6.5.2	Power limitation activated by digital inputs	44
6.5.3	Power limitation process	45
6.5.4	BBR16 power limitation	46
6.6	Setting up an external temperature sensor	47
7	Unit installation	48
7.1	Preparing the installation site	48
7.1.1	Installation site requirements of the outdoor unit	48
7.1.2	Additional installation site requirements of the outdoor unit in cold climates	51
7.2	Mounting the outdoor unit	52
7.2.1	About mounting the outdoor unit	52
7.2.2	Precautions when mounting the outdoor unit	52
7.2.3	To provide the installation structure	52
7.2.4	To install the outdoor unit	53
7.2.5	To provide drainage	55
7.3	Opening and closing the unit	56
7.3.1	About opening the units	56
7.3.2	To open the outdoor unit	56
7.3.3	To rotate the switch box	57
7.3.4	To close the outdoor unit	58
8	Piping installation	59
8.1	Preparing water piping	59
8.1.1	Water circuit requirements	59
8.1.2	Formula to calculate the expansion vessel pre-pressure	61
8.1.3	To check the water volume and flow rate	61
8.1.4	Changing the pre-pressure of the expansion vessel	64
8.1.5	To check the water volume: Examples	64
8.2	Connecting water piping	65

8.2.1	About connecting the water piping	65
8.2.2	Precautions when connecting the water piping	65
8.2.3	To connect the water piping	66
8.2.4	To protect the water circuit against freezing	67
8.2.5	To fill the water circuit	70
8.2.6	To insulate the water piping	71
9	Electrical installation	72
9.1	About connecting the electrical wiring	72
9.1.1	Precautions when connecting the electrical wiring	72
9.1.2	Guidelines when connecting the electrical wiring	73
9.1.3	About electrical compliance	74
9.1.4	About preferential kWh rate power supply	74
9.1.5	Overview of electrical connections except external actuators	75
9.2	Specifications of standard wiring components	77
9.3	Connections to the outdoor unit	77
9.3.1	To connect the electrical wiring to the outdoor unit	79
9.3.2	To connect the main power supply	80
9.3.3	External backup heater kit	83
9.3.4	To connect the user interface	89
9.3.5	To connect the shut-off valve	92
9.3.6	To connect the electricity meters	93
9.3.7	To connect the alarm output	94
9.3.8	To connect the space cooling/heating ON/OFF output	95
9.3.9	To connect the changeover to external heat source	96
9.3.10	To connect the power consumption digital inputs	97
9.3.11	To connect the safety thermostat (normally closed contact)	98
9.3.12	To connect a Smart Grid	98
9.3.13	To connect the WLAN cartridge (delivered as accessory)	102
10	Configuration	103
10.1	Overview: Configuration	103
10.1.1	To access the most used commands	104
10.1.2	To connect the PC cable to the switch box	106
10.2	Configuration wizard	107
10.3	Possible screens	108
10.3.1	Possible screens: Overview	108
10.3.2	Home screen	109
10.3.3	Main menu screen	111
10.3.4	Menu screen	112
10.3.5	Setpoint screen	113
10.3.6	Detailed screen with values	114
10.4	Preset values and schedules	114
10.4.1	Using preset values	114
10.4.2	Using and programming schedules	115
10.4.3	Schedule screen: Example	117
10.4.4	Setting the energy prices	121
10.5	Weather-dependent curve	123
10.5.1	What is a weather-dependent curve?	123
10.5.2	2-points curve	124
10.5.3	Slope-offset curve	125
10.5.4	Using weather-dependent curves	126
10.6	Settings menu	128
10.6.1	Malfunctioning	128
10.6.2	Room	128
10.6.3	Main zone	133
10.6.4	Additional zone	142
10.6.5	Space heating/cooling	146
10.6.6	User settings	156
10.6.7	Information	160
10.6.8	Installer settings	161
10.6.9	Commissioning	180
10.6.10	User profile	180
10.6.11	Operation	181
10.6.12	WLAN	181
10.7	Menu structure: Overview user settings	184
10.8	Menu structure: Overview installer settings	185
11	Commissioning	186
11.1	Overview: Commissioning	186

11.2	Precautions when commissioning.....	187
11.3	Checklist before commissioning.....	187
11.4	Checklist during commissioning.....	188
11.4.1	Minimum flow rate.....	188
11.4.2	Air purge function.....	189
11.4.3	Operation test run.....	191
11.4.4	Actuator test run.....	191
11.4.5	Underfloor heating screed dryout.....	192
12	Hand-over to the user	196
13	Maintenance and service	197
13.1	Maintenance safety precautions.....	197
13.2	Yearly maintenance.....	197
13.2.1	Yearly maintenance outdoor unit: overview.....	197
13.2.2	Yearly maintenance outdoor unit: instructions.....	198
14	Troubleshooting	199
14.1	Overview: Troubleshooting.....	199
14.2	Precautions when troubleshooting.....	199
14.3	Solving problems based on symptoms.....	200
14.3.1	Symptom: The unit is NOT heating or cooling as expected.....	200
14.3.2	Symptom: Hot water does NOT reach the desired temperature.....	200
14.3.3	Symptom: The compressor does NOT start.....	201
14.3.4	Symptom: The system is making gurgling noises after commissioning.....	201
14.3.5	Symptom: The pump is blocked.....	202
14.3.6	Symptom: The pump is making noise (cavitation).....	203
14.3.7	Symptom: The pressure relief valve opens.....	203
14.3.8	Symptom: The water pressure relief valve leaks.....	203
14.3.9	Symptom: The space is NOT sufficiently heated at low outdoor temperatures.....	204
14.3.10	Symptom: The pressure at the tapping point is temporarily unusually high.....	204
14.4	Solving problems based on error codes.....	204
14.4.1	To display the help text in case of a malfunction.....	205
14.4.2	Error codes of the unit.....	205
15	Disposal	210
15.1	Overview: Disposal.....	210
15.2	To pump down.....	210
16	Technical data	212
16.1	Piping diagram: Outdoor unit.....	213
16.2	Wiring diagram: Outdoor unit.....	214
16.3	ESP curve: Outdoor unit.....	222
17	Glossary	223
18	Field settings table	224

1 About this document

Target audience

Authorised installers

Documentation set

This document is part of a documentation set. The complete set consists of:

▪ General safety precautions:

- Safety instructions that you must read before installing
- Format: Paper (in the box of the outdoor unit)

▪ Operation manual:

- Quick guide for basic usage
- Format: Paper (in the box of the outdoor unit)

▪ User reference guide:

- Detailed step-by-step instructions and background information for basic and advanced usage
- Format: Digital files on <https://www.daikin.eu>. Use the search function 🔍 to find your model.

▪ Installation manual:

- Installation instructions
- Format: Paper (in the box of the outdoor unit)

▪ Installer reference guide:

- Preparation of the installation, good practices, reference data, ...
- Format: Digital files on <https://www.daikin.eu>. Use the search function 🔍 to find your model.

▪ Addendum book for optional equipment:

- Additional info about how to install optional equipment
- Format: Paper (in the box of the outdoor unit) + Digital files on <https://www.daikin.eu>. Use the search function 🔍 to find your model.

Latest revisions of the supplied documentation may be available on the regional Daikin website or via your dealer.

The original instructions are written in English. All other languages are translations of the original instructions.

Technical engineering data

- A **subset** of the latest technical data is available on the regional Daikin website (publicly accessible).
- The **full set** of latest technical data is available on the Daikin Business Portal (authentication required).

Online tools

In addition to the documentation set, some online tools are available for installers:

▪ Daikin Technical Data Hub

- Central hub for technical specifications of the unit, useful tools, digital resources, and more.
- Publicly accessible via <https://daikintechdatahub.eu>.

▪ Heating Solutions Navigator

- Digital toolbox that offers a variety of tools to facilitate the installation and configuration of heating systems.
- To access Heating Solutions Navigator, registration to the Stand By Me platform is required. For more information, see <https://professional.standbyme.daikin.eu>.

▪ Daikin e-Care

- Mobile app for installers and service technicians that allows you to register, configure and troubleshoot heating systems.
- The mobile app can be downloaded for iOS and Android devices using the QR codes below. Registration to the Stand By Me platform is required to access the app.

App Store



Google Play



1.1 Meaning of warnings and symbols



DANGER

Indicates a situation that results in death or serious injury.



DANGER: RISK OF ELECTROCUTION

Indicates a situation that could result in electrocution.



DANGER: RISK OF BURNING/SCALDING

Indicates a situation that could result in burning/scalding because of extreme hot or cold temperatures.



DANGER: RISK OF EXPLOSION

Indicates a situation that could result in explosion.



WARNING

Indicates a situation that could result in death or serious injury.



WARNING: FLAMMABLE MATERIAL



CAUTION

Indicates a situation that could result in minor or moderate injury.



NOTICE

Indicates a situation that could result in equipment or property damage.

**INFORMATION**

Indicates useful tips or additional information.

Symbols used on the unit:

Symbol	Explanation
	Before installation, read the installation and operation manual, and the wiring instruction sheet.
	Before performing maintenance and service tasks, read the service manual.
	For more information, see the installer and user reference guide.
	The unit contains rotating parts. Be careful when servicing or inspecting the unit.

Symbols used in the documentation:

Symbol	Explanation
	Indicates a figure title or a reference to it. Example: "▲ 1-3 Figure title" means "Figure 3 in chapter 1".
	Indicates a table title or a reference to it. Example: "■ 1-3 Table title" means "Table 3 in chapter 1".

1.2 Installer reference guide at a glance

Chapter	Description
About the documentation	What documentation exists for the installer
General safety precautions	Safety instructions that you must read before installing
Specific installer safety instructions	
About the box	How to handle the box, unpack the units and remove their accessories
About the units and options	<ul style="list-style-type: none"> ▪ How to identify the units ▪ Possible combinations of units and options
Application guidelines	Various installation setups of the system
Unit installation	What to do and know to install the system, including information on how to prepare for an installation
Piping installation	What to do and know to install the piping of the system, including information on how to prepare for an installation
Electrical installation	What to do and know to install the electrical components of the system, including information on how to prepare for an installation

Chapter	Description
Finishing the outdoor unit installation	What to do after unit installation, piping installation and electrical installation
Configuration	What to do and know to configure the system after it is installed
Commissioning	What to do and know to commission the system after it is configured
Hand-over to the user	What to give and explain to the user
Maintenance and service	How to maintain and service the units
Troubleshooting	What to do in case of problems
Disposal	How to dispose of the system
Technical data	Specifications of the system
Glossary	Definition of terms
Field settings table	<p>Table to be filled in by the installer, and kept for future reference</p> <p>Note: There is also an installer settings table in the user reference guide. This table has to be filled in by the installer and handed over to the user.</p>

2 General safety precautions

In this chapter

2.1	For the installer.....	9
2.1.1	General.....	9
2.1.2	Installation site.....	10
2.1.3	Refrigerant — in case of R410A or R32.....	10
2.1.4	Water.....	12
2.1.5	Electrical.....	12

2.1 For the installer

2.1.1 General

If you are NOT sure how to install or operate the unit, contact your dealer.



DANGER: RISK OF BURNING/SCALDING

- Do NOT touch the refrigerant piping, water piping or internal parts during and immediately after operation. It could be too hot or too cold. Give it time to return to normal temperature. If you MUST touch it, wear protective gloves.
- Do NOT touch any accidental leaking refrigerant.



WARNING

Improper installation or attachment of equipment or accessories could result in electrical shock, short-circuit, leaks, fire or other damage to the equipment. ONLY use accessories, optional equipment and spare parts made or approved by Daikin unless otherwise specified.



WARNING

Make sure installation, testing and applied materials comply with applicable legislation (on top of the instructions described in the Daikin documentation).



WARNING

Tear apart and throw away plastic packaging bags so that nobody, especially NOT children, can play with them. **Possible consequence:** suffocation.



WARNING

Provide adequate measures to prevent that the unit can be used as a shelter by small animals. Small animals that make contact with electrical parts can cause malfunctions, smoke or fire.



CAUTION

Wear adequate personal protective equipment (protective gloves, safety glasses,...) when installing, maintaining or servicing the system.



CAUTION

Do NOT touch the air inlet or aluminium fins of the unit.



CAUTION

- Do NOT place any objects or equipment on top of the unit.
- Do NOT sit, climb or stand on the unit.



NOTICE

Works executed on the outdoor unit are best done under dry weather conditions to avoid water ingress.

In accordance with the applicable legislation, it might be necessary to provide a logbook with the product containing at least: information on maintenance, repair work, results of tests, stand-by periods,...

Also, at least, following information MUST be provided at an accessible place at the product:

- Instructions for shutting down the system in case of an emergency
- Name and address of fire department, police and hospital
- Name, address and day and night telephone numbers for obtaining service

In Europe, EN378 provides the necessary guidance for this logbook.

2.1.2 Installation site

- Provide sufficient space around the unit for servicing and air circulation.
- Make sure the installation site withstands the weight and vibration of the unit.
- Make sure the area is well ventilated. Do NOT block any ventilation openings.
- Make sure the unit is level.

Do NOT install the unit in the following places:

- In potentially explosive atmospheres.
- In places where there is machinery that emits electromagnetic waves. Electromagnetic waves may disturb the control system, and cause malfunction of the equipment.
- In places where there is a risk of fire due to the leakage of flammable gases (example: thinner or gasoline), carbon fibre, ignitable dust.
- In places where corrosive gas (example: sulphurous acid gas) is produced. Corrosion of copper pipes or soldered parts may cause the refrigerant to leak.

2.1.3 Refrigerant — in case of R410A or R32

If applicable. See the installation manual or installer reference guide of your application for more information.



DANGER: RISK OF EXPLOSION

Pump down – Refrigerant leakage. If you want to pump down the system, and there is a leak in the refrigerant circuit:

- Do NOT use the unit's automatic pump down function, with which you can collect all refrigerant from the system into the outdoor unit. **Possible consequence:** Self-combustion and explosion of the compressor because of air going into the operating compressor.
- Use a separate recovery system so that the unit's compressor does NOT have to operate.

**WARNING**

During tests, NEVER pressurise the product with a pressure higher than the maximum allowable pressure (as indicated on the nameplate of the unit).

**WARNING**

Take sufficient precautions in case of refrigerant leakage. If refrigerant gas leaks, ventilate the area immediately. Possible risks:

- Excessive refrigerant concentrations in a closed room can lead to oxygen deficiency.
- Toxic gas might be produced if refrigerant gas comes into contact with fire.

**WARNING**

ALWAYS recover the refrigerant. Do NOT release them directly into the environment. Use a vacuum pump to evacuate the installation.

**WARNING**

Make sure there is no oxygen in the system. Refrigerant may ONLY be charged after performing the leak test and the vacuum drying.

Possible consequence: Self-combustion and explosion of the compressor because of oxygen going into the operating compressor.

**NOTICE**

- To avoid compressor breakdown, do NOT charge more than the specified amount of refrigerant.
- When the refrigerant system is to be opened, refrigerant MUST be treated according to the applicable legislation.

**NOTICE**

Make sure refrigerant piping installation complies with applicable legislation. In Europe, EN378 is the applicable standard.



**NOTICE**

Make sure the field piping and connections are NOT subjected to stress.

**NOTICE**

After all the piping has been connected, make sure there is no gas leak. Use nitrogen to perform a gas leak detection.

- In case recharge is required, see the nameplate or the refrigerant charge label of the unit. It states the type of refrigerant and necessary amount.
- Either if the unit is factory charged with refrigerant or the unit is non-charged, you might need to charge additional refrigerant, depending on the pipe sizes and pipe lengths of the system.
- ONLY use tools exclusively for the refrigerant type used in the system, this to ensure pressure resistance and prevent foreign materials from entering into the system.
- Charge the liquid refrigerant as follows:

If	Then
A siphon tube is present (i.e., the cylinder is marked with "Liquid filling siphon attached")	Charge with the cylinder upright. 
A siphon tube is NOT present	Charge with the cylinder upside down. 

- Open refrigerant cylinders slowly.
- Charge the refrigerant in liquid form. Adding it in gas form may prevent normal operation.

 **CAUTION**
When the refrigerant charging procedure is done or when pausing, close the valve of the refrigerant tank immediately. If the valve is NOT closed immediately, remaining pressure might charge additional refrigerant. **Possible consequence:** Incorrect refrigerant amount.

2.1.4 Water

If applicable. See the installation manual or installer reference guide of your application for more information.

 **NOTICE**
Make sure water quality complies with EU directive 2020/2184.

2.1.5 Electrical

 **DANGER: RISK OF ELECTROCUTION**

- Turn OFF all power supply before removing the switch box cover, connecting electrical wiring or touching electrical parts.
- Disconnect the power supply for more than 10 minutes, and measure the voltage at the terminals of main circuit capacitors or electrical components before servicing. The voltage MUST be less than 50 V DC before you can touch electrical components. For the location of the terminals, see the wiring diagram.
- Do NOT touch electrical components with wet hands.
- Do NOT leave the unit unattended when the service cover is removed.

 **WARNING**
If NOT factory installed, a main switch or other means for disconnection, having a contact separation in all poles providing full disconnection under overvoltage category III condition, MUST be installed in the fixed wiring.

**WARNING**

- ONLY use copper wires.
- Make sure the field wiring complies with the applicable legislation.
- All field wiring MUST be performed in accordance with the wiring diagram supplied with the product.
- NEVER squeeze bundled cables and make sure they do NOT come in contact with the piping and sharp edges. Make sure no external pressure is applied to the terminal connections.
- Make sure to install earth wiring. Do NOT earth the unit to a utility pipe, surge absorber, or telephone earth. Incomplete earth may cause electrical shock.
- Make sure to use a dedicated power circuit. NEVER use a power supply shared by another appliance.
- Make sure to install the required fuses or circuit breakers.
- Make sure to install an earth leakage protector. Failure to do so may cause electrical shock or fire.
- When installing the earth leakage protector, make sure it is compatible with the inverter (resistant to high frequency electric noise) to avoid unnecessary opening of the earth leakage protector.

**WARNING**

- After finishing the electrical work, confirm that each electrical component and terminal inside the electrical components box is connected securely.
- Make sure all covers are closed before starting up the unit.

**CAUTION**

- When connecting the power supply: connect the earth cable first, before making the current-carrying connections.
- When disconnecting the power supply: disconnect the current-carrying cables first, before separating the earth connection.
- The length of the conductors between the power supply stress relief and the terminal block itself MUST be as such that the current-carrying wires are tightened before the earth wire is in case the power supply is pulled loose from the stress relief.

**NOTICE**

Precautions when laying power wiring:



- Do NOT connect wiring of different thicknesses to the power terminal block (slack in the power wiring may cause abnormal heat).
- When connecting wiring which is the same thickness, do as shown in the figure above.
- For wiring, use the designated power wire and connect firmly, then secure to prevent outside pressure being exerted on the terminal board.
- Use an appropriate screwdriver for tightening the terminal screws. A screwdriver with a small head will damage the head and make proper tightening impossible.
- Over-tightening the terminal screws may break them.

Install power cables at least 1 meter away from televisions or radios to prevent interference. Depending on the radio waves, a distance of 1 meter may NOT be sufficient.

**NOTICE**

ONLY applicable if the power supply is three-phase, and the compressor has an ON/OFF starting method.

If there exists the possibility of reversed phase after a momentary black out and the power goes ON and OFF while the product is operating, attach a reversed phase protection circuit locally. Running the product in reversed phase can break the compressor and other parts.

3 Specific installer safety instructions

Always observe the following safety instructions and regulations.

Installation site (see "7.1 Preparing the installation site" [▶ 48])



WARNING

Follow the service space dimensions in this manual for correct installation of the unit. See "7.1.1 Installation site requirements of the outdoor unit" [▶ 48].

Special requirements for R32 (see "7.1.1 Installation site requirements of the outdoor unit" [▶ 48])



WARNING

- Do NOT pierce or burn refrigerant cycle parts.
- Do NOT use means to accelerate the defrosting process or to clean the equipment, other than those recommended by the manufacturer.
- Be aware that R32 refrigerant does NOT contain an odour.



WARNING

The appliance shall be stored so as to prevent mechanical damage and in a well-ventilated room without continuously operating ignition sources (example: open flames, an operating gas appliance or an operating electric heater).



WARNING

Make sure installation, servicing, maintenance and repair comply with instructions from Daikin and with applicable legislation and are executed ONLY by authorised persons.

Mounting the outdoor unit (see "7.2 Mounting the outdoor unit" [▶ 52])



WARNING

Fixing method of the outdoor unit MUST be in accordance with the instructions from this manual. See "7.2 Mounting the outdoor unit" [▶ 52].

To install the outdoor unit (see "7.2.4 To install the outdoor unit" [▶ 53])



CAUTION

To avoid injury, do NOT touch the air inlet or aluminium fins of the unit.



CAUTION

Do NOT remove the protective cardboard before the unit is installed properly.

Opening and closing the unit (see "7.3 Opening and closing the unit" [▶ 56])



DANGER: RISK OF ELECTROCUTION



DANGER: RISK OF BURNING/SCALDING

Piping installation (see "8 Piping installation" [▶ 59])



WARNING

The field piping method **MUST** be in accordance with the instructions from this manual. See "[8 Piping installation](#)" [▶ 59].

In case of freeze protection by glycol:



WARNING

Ethylene glycol is toxic.



WARNING

Due to the presence of glycol, corrosion of the system is possible. Uninhibited glycol will turn acidic under the influence of oxygen. This process is accelerated by the presence of copper and high temperatures. The acidic uninhibited glycol attacks metal surfaces and forms galvanic corrosion cells that cause severe damage to the system. Therefore it is important that:

- the water treatment is correctly executed by a qualified water specialist,
- a glycol with corrosion inhibitors is selected to counteract acids formed by the oxidation of glycols,
- no automotive glycol is used because their corrosion inhibitors have a limited lifetime and contain silicates which can foul or plug the system,
- galvanized pipes are **NOT** used in glycol systems since the presence may lead to the precipitation of certain components in the glycol's corrosion inhibitor.

Electrical installation (see "9 Electrical installation" [▶ 72])



WARNING

Electrical wiring connection method **MUST** be in accordance with the instructions from:

- This manual. See "[9 Electrical installation](#)" [▶ 72].
- The wiring diagram of the outdoor unit, which is delivered with the unit, located on the inside of the front plate. For a translation of its legend, see "[16.2 Wiring diagram: Outdoor unit](#)" [▶ 214].



DANGER: RISK OF ELECTROCUTION



WARNING

ALWAYS use multicore cable for power supply cables.



CAUTION

Do **NOT** push or place redundant cable length into the unit.



WARNING

The backup heater **MUST** have a dedicated power supply and **MUST** be protected by the safety devices required by the applicable legislation.

**CAUTION**

To guarantee the unit is completely earthed, ALWAYS connect the backup heater power supply and the earth cable.

**WARNING**

Stripped wire. Make sure that stripped wire cannot make contact with possible water on the bottom plate.

Commissioning (see "11 Commissioning" [▶ 186])**WARNING**

Commissioning method MUST be in accordance with the instructions from this manual. See "11 Commissioning" [▶ 186].

4 About the box

Keep the following in mind:

- At delivery, the unit **MUST** be checked for damage and completeness. Any damage or missing parts **MUST** be reported immediately to the claims agent of the carrier.
- Bring the packed unit as close as possible to its final installation position to prevent damage during transport.
- Prepare in advance the path along which you want to bring the unit to its final installation position.

In this chapter

4.1	Outdoor unit	18
4.1.1	To unpack the outdoor unit	18
4.1.2	To remove the accessories from the outdoor unit	18

4.1 Outdoor unit

4.1.1 To unpack the outdoor unit

- 1** Cut straps and remove the cardboard.

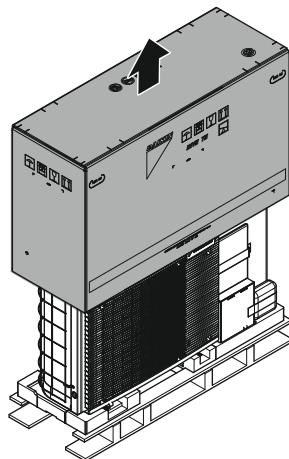

- 2** Remove the top packaging.

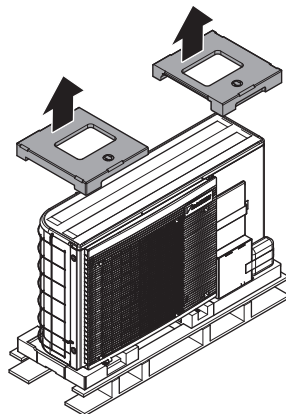

4.1.2 To remove the accessories from the outdoor unit

- 1** Remove the accessories on top and in front of the unit.

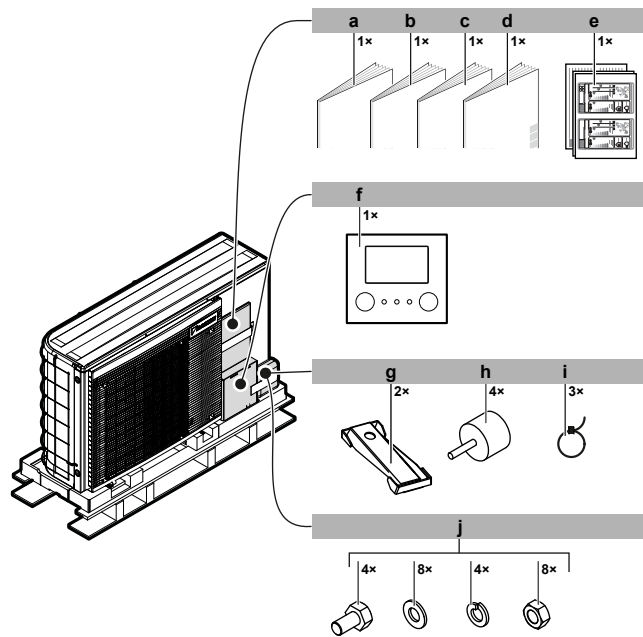

- a** General safety precautions
- b** Operation manual
- c** Installation manual
- d** Addendum book for optional equipment
- e** Energy label
- f** User interface (front plate, rear plate, screws, and wall plugs)
- g** Unit mounting plate
- h** Vibration dampers
- i** Cable tie
- j** Bolts, nuts, washers, and spring washers

- 2** After opening the unit (see "7.3.2 To open the outdoor unit" [▶ 56]), remove the accessory inside the unit.

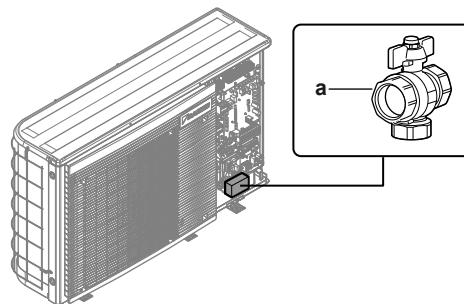

- a** Shutoff valve

5 About the units and options

In this chapter

5.1	Identification.....	20
5.1.1	Identification label: Outdoor unit.....	20
5.2	Combining units and options.....	21
5.2.1	Possible options for the outdoor unit.....	21

5.1 Identification

5.1.1 Identification label: Outdoor unit

Location

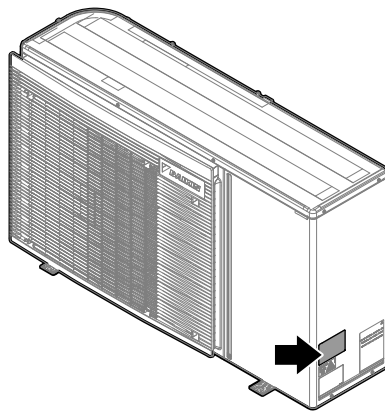

Model identification

Example: EW Y A 006 D2 V3 P -H

Code	Explanation
EW	European water chiller
Y	A=Cooling only Y=Reversible (heating+cooling)
A	Refrigerant R32
006	Capacity class
D2	Model series
V3	Power supply: V3=1N~, 230 V AC, 50 Hz
P	Pump included
-H	Heater tape included ^(a)

^(a) Outdoor units that have -H in their model name feature heater tape around their internal water piping, this to prevent the piping from freezing at negative ambient temperatures.

5.2 Combining units and options



INFORMATION

Certain options may NOT be available in your country.

5.2.1 Possible options for the outdoor unit

Room thermostat (EKRTWA, EKRTTB)

You can connect an optional room thermostat to the outdoor unit. This thermostat can either be wired (EKRTWA) or wireless (EKRTTB).

For installation instructions, see the installation manual of the room thermostat and addendum book for optional equipment.

Remote sensor for wireless thermostat (EKRTETSB)

You can use the remote indoor temperature sensor (EKRTETSB) only in combination with the wireless thermostat (EKRTTB).

For installation instructions, see the installation manual of the room thermostat and the addendum book for optional equipment.

Digital I/O PCB (EKRP1HBAA)

The digital I/O PCB is required to provide following signals:

- Alarm output
- Space heating/cooling ON/OFF output
- Changeover to external heat source

For installation instructions, see the installation manual of the digital I/O PCB and addendum book for optional equipment.

Demand PCB (EKRP1AHTA)

To enable the power saving consumption control by digital inputs you MUST install the demand PCB.

For installation instructions, see the installation manual of the demand PCB and addendum book for optional equipment.

Remote indoor sensor (KRCS01-1)

By default the internal sensor of the dedicated Human Comfort Interface (BRC1HHDA used as room thermostat) will be used as room temperature sensor.

As an option the remote indoor sensor can be installed to measure the room temperature on another location.

For installation instructions, see the installation manual of the remote indoor sensor and addendum book for optional equipment.



INFORMATION

- The remote indoor sensor can only be used in case the user interface is configured with room thermostat functionality.
- You can only connect either the remote indoor sensor or the remote outdoor sensor.

Remote outdoor sensor (EKRSKA1)

By default the sensor inside the outdoor unit will be used to measure the outdoor temperature.

As an option the remote outdoor sensor can be installed to measure the outdoor temperature on another location (e.g. to avoid direct sunlight) to have an improved system behaviour.

For installation instructions, see the installation manual of the remote outdoor sensor and the addendum book for optional equipment.



INFORMATION

You can only connect either the remote indoor sensor or the remote outdoor sensor.

PC cable (EKPCAB4)

The PC cable makes a connection between the hydro PCB (A1P) of the outdoor unit and a PC. It gives the possibility to update the hydro software and EEPROM.

For installation instructions, see:

- Installation manual of the PC cable
- ["10.1.2 To connect the PC cable to the switch box"](#) [▶ 106]

External backup heater kit (EKLBUHCB6W1) + bypass valve kit (EKMBHBP1)

For reversible models, you can install the external backup heater kit (EKLBUHCB6W1).

For installation instructions, see:

- Installation manual of the external backup heater kit
- ["To connect the backup heater kit"](#) [▶ 83] (this topic partially supersedes the installation manual of the backup heater)

If you install the external backup heater kit, then under certain conditions you also need to install a bypass valve kit (EKMBHBP1). See:

- ["Bypass valve kit necessity"](#) [▶ 87]
- ["To connect the bypass valve kit"](#) [▶ 88] (this topic supersedes the instruction sheet delivered with the bypass valve kit)

Universal centralised controller (EKCC8-W)

Controller for cascade control.

Bizone kit (EKMIKPOA or EKMIKPHA)

You can install an optional bizone kit.

For installation instructions, see the installation manual of the bizone kit.

See also:

- ["6.2.3 Multiple rooms – Two LWT zones"](#) [▶ 33]
- ["Bizone kit"](#) [▶ 178]

Human Comfort Interface (BRC1HHDA) used as room thermostat

- The Human Comfort Interface (HCI) used as room thermostat can only be used in combination with the user interface connected to the outdoor unit.
- The Human Comfort Interface (HCI) used as room thermostat needs to be installed in the room that you want to control.

For installation instructions, see the installation and operation manual of the Human Comfort Interface (HCI) as room thermostat, and the addendum book for optional equipment.

Domestic hot water tank thermistor (EKTESE1, EKTESE2)

To increase the maximum distance between the domestic hot water tank and the outdoor unit, a 30 m thermistor can be connected.

For stainless steel tanks EKTESE1 can be connected and for polypropylene tanks EKTESE2 can be connected.

For installation instructions, see the installation manual of the domestic hot water tank, and the addendum book for optional equipment.

Flow switch (EKFLSW2)

If you add glycol to the water, you also need to install a flow switch (and set [E-OD]=1).

For installation instructions, see the installation manual of the flow switch.

Smart grid relay kit (EKRELSG)

The installation of the optional Smart grid relay kit is required in case of high voltage Smart grid contacts (EKRELSG).

For installation instructions, see "9.3.12 To connect a Smart Grid" [▶ 98].

WLAN cartridge (BRP069A78)

You can install the wireless LAN cartridge to control the system via a smartphone app.

For installation instructions, see the installation manual of the WLAN cartridge.

LAN adapter for smartphone control (BRP069A62)

You can install this LAN adapter to control the system via a smartphone app.

For installation instructions, see the installation manual of the LAN adapter.

LAN adapter for smartphone control + Smart Grid applications (BRP069A61)

You can install this LAN adapter to:

- Control the system via a smartphone app.
- Use the system in various Smart Grid applications.

For installation instructions, see the installation manual of the LAN adapter.

6 Application guidelines



INFORMATION

Heating is only applicable in case of reversible models.

In this chapter

6.1	Overview: Application guidelines	24
6.2	Setting up the space heating/cooling system	25
6.2.1	Single room.....	26
6.2.2	Multiple rooms – One LWT zone	30
6.2.3	Multiple rooms – Two LWT zones	33
6.3	Setting up an auxiliary heat source for space heating.....	36
6.4	Setting up the energy metering	39
6.4.1	Produced heat	39
6.4.2	Consumed energy	40
6.4.3	Power supply layouts with power meters	40
6.5	Setting up the power consumption control.....	43
6.5.1	Permanent power limitation.....	44
6.5.2	Power limitation activated by digital inputs	44
6.5.3	Power limitation process	45
6.5.4	BBR16 power limitation	46
6.6	Setting up an external temperature sensor.....	47

6.1 Overview: Application guidelines

The purpose of the application guidelines is to give a glance of the possibilities of the heat pump system.



NOTICE

- The illustrations in the application guidelines are meant for reference only, and are NOT to be used as detailed hydraulic diagrams. The detailed hydraulic dimensioning and balancing are NOT shown, and are the responsibility of the installer.
- For more information about the configuration settings to optimize heat pump operation, see "[10 Configuration](#)" [▶ 103].

This chapter contains application guidelines for:

- Setting up the space heating/cooling system
- Setting up an auxiliary heat source for space heating
- Setting up the energy metering
- Setting up the power consumption control
- Setting up an external temperature sensor

**NOTICE**

Certain types of fan coil units are able to receive input of the outdoor unit operation mode (cooling or heating X2M/3 and X2M/4) and/or to send output of the fan coil unit thermostatic condition (main zone: X2M/30 and X2M/35; additional zone: X2M/30 and X2M/35a).

The application guidelines illustrate the possibility of receiving or sending digital input/output. This functionality can only be used in case the fan coil unit has such features and the signals meet following requirements:

- Output of outdoor unit (input to fan coil unit): cooling/heating signal=230 V (cooling=230 V, heating=0 V).
- Input to outdoor unit (output of fan coil unit): thermostat ON/OFF signal=voltage-free contact (closed contact=thermo ON, open contact=thermo OFF).

6.2 Setting up the space heating/cooling system

The heat pump system supplies leaving water to heat emitters in one or more rooms.

Because the system offers a wide flexibility to control the temperature in each room, you need to answer the following questions first:

- How many rooms are heated or cooled by the heat pump system?
- Which heat emitter types are used in each room and what is their design leaving water temperature?

Once the space heating/cooling requirements are clear, we recommend to follow the setup guidelines below.

**NOTICE**

If an external room thermostat is used, the external room thermostat will control the room frost protection. However, the room frost protection is only possible if [C.2] **Space heating/cooling=On**.

**INFORMATION**

In case an external room thermostat is used and room frost protection needs to be guaranteed in all conditions, then you have to set **Emergency** [9.5.1] to one of the following:

- **Automatic**
- **auto SH reduced/DHW off**

**NOTICE**

A differential pressure bypass valve can be integrated in the system. Keep in mind that this valve might not be shown on the illustrations.

6.2.1 Single room

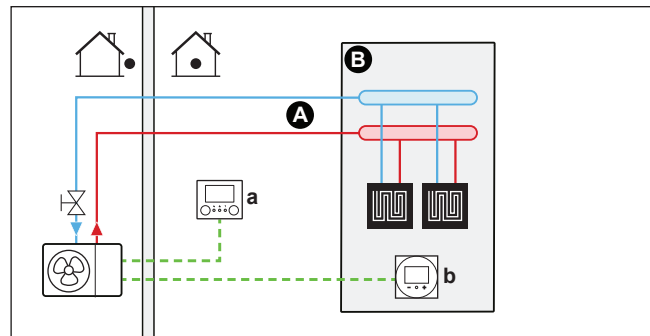
Underfloor heating or radiators – Wired room thermostat**Setup**

- A** Main leaving water temperature zone
- B** One single room
- a** User interface (delivered as accessory)
- b** Dedicated Human Comfort Interface (BRC1HHDA used as room thermostat)

- For more information about connecting the electrical wiring to the unit, see "9.3 Connections to the outdoor unit" [▶ 77].
- The underfloor heating or radiators are directly connected to the outdoor unit – or to the external backup heater kit, if there is one.
- The room temperature is controlled by the dedicated Human Comfort Interface (BRC1HHDA used as room thermostat).

Configuration

Setting	Value
Unit temperature control: ▪ #: [2.9] ▪ Code: [C-07]	2 (Room thermostat): Unit operation is decided based on the ambient temperature of the dedicated Human Comfort Interface.
Number of water temperature zones: ▪ #: [4.4] ▪ Code: [7-02]	0 (Single zone): Main

Benefits

- **Highest comfort and efficiency.** The smart room thermostat functionality can decrease or increase the desired leaving water temperature based on the actual room temperature (modulation). This results in:
 - Stable room temperature matching the desired temperature (higher comfort)
 - Less ON/OFF cycles (more quiet, higher comfort and higher efficiency)
 - Lowest possible leaving water temperature (higher efficiency)
- **Easy.** You can easily set the desired room temperature via the user interface:
 - For your daily needs, you can use preset values and schedules.
 - To deviate from your daily needs, you can temporarily overrule the preset values and schedules, or use the holiday mode.

Underfloor heating or radiators – Wireless room thermostat

Setup

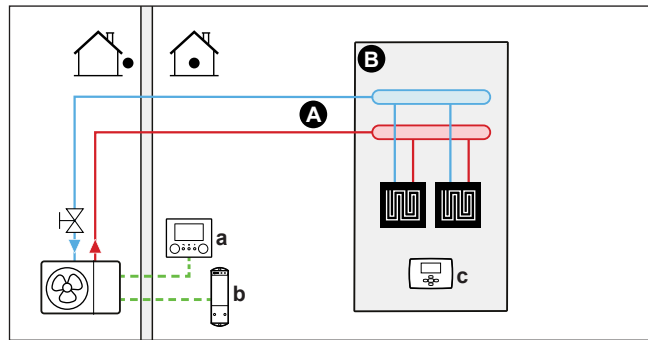

- A** Main leaving water temperature zone
- B** One single room
- a** User interface (delivered as accessory)
- b** Receiver for wireless external room thermostat
- c** Wireless external room thermostat

- For more information about connecting the electrical wiring to the unit, see ["9.3 Connections to the outdoor unit"](#) [▶ 77].
- The underfloor heating or radiators are directly connected to the outdoor unit – or to the external backup heater kit, if there is one.
- The room temperature is controlled by the wireless external room thermostat (optional equipment EKRTTB).

Configuration

Setting	Value
Unit temperature control: ▪ #: [2.9] ▪ Code: [C-07]	1 (External room thermostat): Unit operation is decided by the external thermostat.
Number of water temperature zones: ▪ #: [4.4] ▪ Code: [7-02]	0 (Single zone): Main
External room thermostat for the main zone: ▪ #: [2.A] ▪ Code: [C-05]	1 (1 contact): When the used external room thermostat can only send a thermo ON/OFF condition. No separation between heating or cooling demand.

Benefits

- **Wireless.** The Daikin external room thermostat is available in a wireless version.
- **Efficiency.** Although the external room thermostat only sends ON/OFF signals, it is specifically designed for the heat pump system.
- **Comfort.** In case of underfloor heating, the wireless external room thermostat prevents condensation on the floor during cooling operation by measuring the room humidity.

Fan coil units

Setup

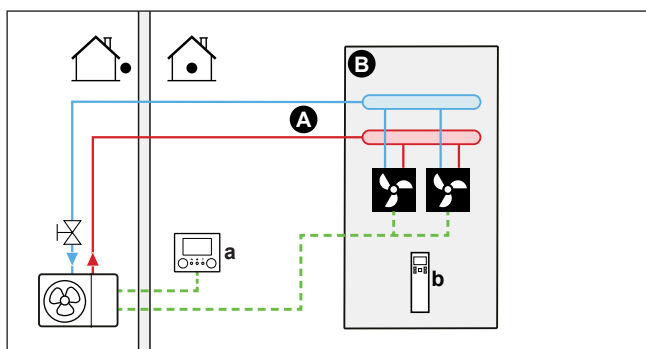

- A** Main leaving water temperature zone
- B** One single room
- a** User interface (delivered as accessory)
- b** Remote controller of the fan coil units

- For more information about connecting the electrical wiring to the unit, see "9.3 Connections to the outdoor unit" [▶ 77].
- The fan coil units are directly connected to the outdoor unit – or to the external backup heater kit, if there is one.
- The desired room temperature is set via the remote controller of the fan coil units.
- The space heating/cooling demand signal is sent to one digital input on the outdoor unit (X2M/35 and X2M/30).
- The space operation mode is sent to the fan coil units by one digital output on the outdoor unit (X2M/4 and X2M/3).



INFORMATION

When using multiple fan coil units, make sure each one receives the infrared signal from the remote controller of the fan coil units.

Configuration

Setting	Value
Unit temperature control: ▪ #: [2.9] ▪ Code: [C-07]	1 (External room thermostat): Unit operation is decided by the external thermostat.
Number of water temperature zones: ▪ #: [4.4] ▪ Code: [7-02]	0 (Single zone): Main
External room thermostat for the main zone: ▪ #: [2.A] ▪ Code: [C-05]	1 (1 contact): When the used external room thermostat or fan coil unit can only send a thermo ON/OFF condition. No separation between heating or cooling demand.

Benefits

- **Cooling.** The fan coil unit offers, besides heating capacity, also excellent cooling capacity.
- **Efficiency.** Optimal energy efficiency because of the interlink function.

- **Stylish.**

Combination: Underfloor heating + Fan coil units

- Space heating is provided by:
 - The underfloor heating
 - The fan coil units
- Space cooling is provided by the fan coil units only. The underfloor heating is shut off by the shut-off valve.

Setup

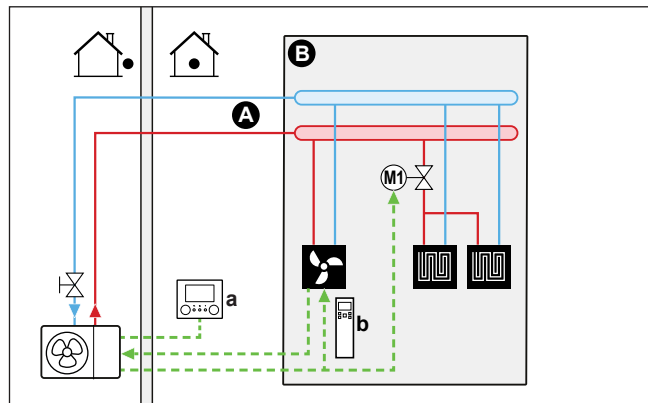

- A** Main leaving water temperature zone
- B** One single room
- a** User interface (delivered as accessory)
- b** Remote controller of the fan coil units

- For more information about connecting the electrical wiring to the unit, see ["9.3 Connections to the outdoor unit"](#) [▶ 77].
- The fan coil units are directly connected to the outdoor unit – or to the external backup heater kit, if there is one.
- A shut-off valve (field supply) is installed before the underfloor heating to prevent condensation on the floor during cooling operation.
- The desired room temperature is set via the remote controller of the fan coil units.
- The space heating/cooling demand signal is sent to one digital input on the outdoor unit (X2M/35 and X2M/30).
- The space operation mode is sent by one digital output (X2M/4 and X2M/3) on the outdoor unit to:
 - The fan coil units
 - The shut-off valve

Configuration

Setting	Value
Unit temperature control: <ul style="list-style-type: none"> ▪ #: [2.9] ▪ Code: [C-07] 	1 (External room thermostat): Unit operation is decided by the external thermostat.
Number of water temperature zones: <ul style="list-style-type: none"> ▪ #: [4.4] ▪ Code: [7-02] 	0 (Single zone): Main

Setting	Value
External room thermostat for the main zone: <ul style="list-style-type: none"> ▪ #: [2.A] ▪ Code: [C-05] 	1 (1 contact): When the used external room thermostat or fan coil unit can only send a thermo ON/OFF condition. No separation between heating or cooling demand.

Benefits

- **Cooling.** Fan coil units provide, besides heating capacity, also excellent cooling capacity.
- **Efficiency.** Underfloor heating has the best performance with the heat pump system.
- **Comfort.** The combination of the two heat emitter types provides:
 - The excellent heating comfort of the underfloor heating
 - The excellent cooling comfort of the fan coil units

6.2.2 Multiple rooms – One LWT zone

If only one leaving water temperature zone is needed because the design leaving water temperature of all heat emitters is the same, you do NOT need a mixing valve station (cost effective).

Example: If the heat pump system is used to heat up one floor where all the rooms have the same heat emitters.

Underfloor heating or radiators – Thermostatic valves

If you are heating up rooms with underfloor heating or radiators, a very common way is to control the temperature of the main room by using a thermostat (this can either be the dedicated Human Comfort Interface (BRC1HHDA) or an external room thermostat), while the other rooms are controlled by so-called thermostatic valves, which open or close depending on the room temperature.

Setup

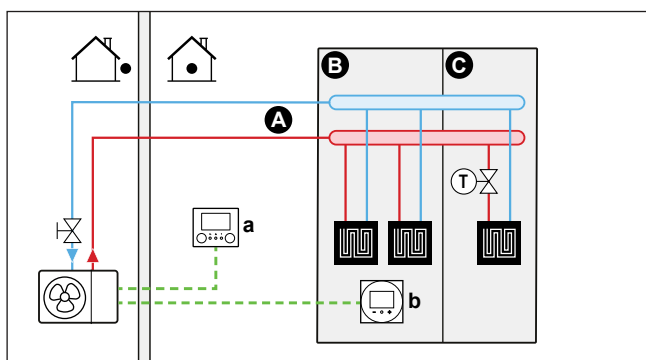

- A** Main leaving water temperature zone
- B** Room 1
- C** Room 2
- a** User interface (delivered as accessory)
- b** Dedicated Human Comfort Interface (BRC1HHDA used as room thermostat)

- For more information about connecting the electrical wiring to the unit, see "[9.3 Connections to the outdoor unit](#)" [▶ 77].
- The underfloor heating of the main room is directly connected to the outdoor unit – or to the external backup heater kit, if there is one.

- The room temperature of the main room is controlled by the dedicated Human Comfort Interface (BRC1HHDA used as room thermostat).
- A thermostatic valve is installed before the underfloor heating in each of the other rooms.



INFORMATION

Mind situations where the main room can be heated by another heating source.
Example: Fireplaces.

Configuration

Setting	Value
Unit temperature control: <ul style="list-style-type: none"> ▪ #: [2.9] ▪ Code: [C-07] 	2 (Room thermostat): Unit operation is decided based on the ambient temperature of the dedicated Human Comfort Interface.
Number of water temperature zones: <ul style="list-style-type: none"> ▪ #: [4.4] ▪ Code: [7-02] 	0 (Single zone): Main

Benefits

- **Easy.** Same installation as for one room, but with thermostatic valves.

Fan coil units – Multiple rooms

Setup

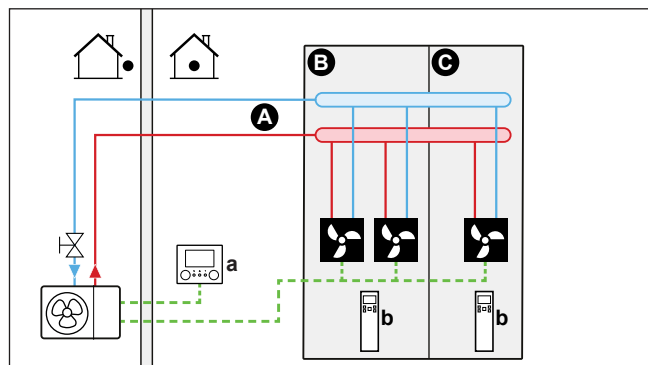

- A** Main leaving water temperature zone
- B** Room 1
- C** Room 2
- a** User interface (delivered as accessory)
- b** Remote controller of the fan coil units

- For more information about connecting the electrical wiring to the unit, see ["9.3 Connections to the outdoor unit"](#) [▶ 77].
- The desired room temperature is set via the remote controller of the fan coil units.
- The user interface connected to the outdoor unit decides the space operation mode.
- The heating or cooling demand signals of each fan coil unit are connected in parallel to the digital input on the outdoor unit (X2M/35 and X2M/30). The outdoor unit will only supply leaving water temperature when there is an actual demand.

Configuration

Setting	Value
Unit temperature control: <ul style="list-style-type: none"> ▪ #: [2.9] ▪ Code: [C-07] 	1 (External room thermostat): Unit operation is decided by the external thermostat.
Number of water temperature zones: <ul style="list-style-type: none"> ▪ #: [4.4] ▪ Code: [7-02] 	0 (Single zone): Main

Benefits

Compared with fan coil units for one room:

- **Comfort.** You can set the desired room temperature, including schedules, for each room via the remote controller of the fan coil unit.

Combination: Underfloor heating + Fan coil units – Multiple rooms

Setup

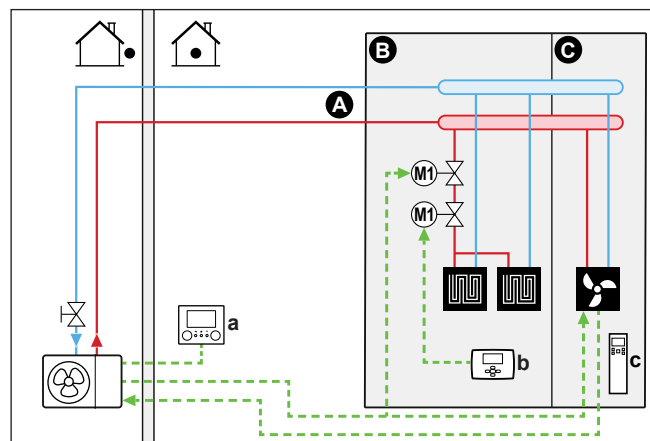

- A** Main leaving water temperature zone
- B** Room 1
- C** Room 2
- a** User interface (delivered as accessory)
- b** External room thermostat
- c** Remote controller of the fan coil units

- For more information about connecting the electrical wiring to the unit, see "9.3 Connections to the outdoor unit" [▶ 77].
- For each room with fan coil units: The fan coil units are directly connected to the outdoor unit – or to the external backup heater kit, if there is one.
- For each room with underfloor heating: Two shut-off valves (field supply) are installed before the underfloor heating:
 - A shut-off valve to prevent hot water supply when the room has no heating demand
 - A shut-off valve to prevent condensation on the floor during cooling operation of the rooms with fan coil units.
- For each room with fan coil units: The desired room temperature is set via the remote controller of the fan coil units.
- For each room with underfloor heating: The desired room temperature is set via the external room thermostat (wired or wireless).

- The user interface connected to the outdoor unit decides the space operation mode. Mind that the operation mode on each external room thermostat and remote controller of the fan coil units must be set to match the outdoor unit.

Configuration

Setting	Value
Unit temperature control: ▪ #: [2.9] ▪ Code: [C-07]	0 (Leaving water): Unit operation is decided based on the leaving water temperature.
Number of water temperature zones: ▪ #: [4.4] ▪ Code: [7-02]	0 (Single zone): Main

6.2.3 Multiple rooms – Two LWT zones

If the heat emitters selected for each room are designed for different leaving water temperatures, you can use different leaving water temperature zones (maximum 2).

In this document:

- Main zone = Zone with the lowest design temperature in heating, and the highest design temperature in cooling



CAUTION

If there is more than one leaving water zone, ALWAYS install a mixing valve station in the main zone to decrease (in heating)/increase (in cooling) the leaving water temperature when the additional zone has demand.

Typical example:

Room (zone)	Heat emitters: Design temperature
Living room (main zone)	Underfloor heating: ▪ In heating: 35°C ▪ In cooling ^(a) : 20°C (only refreshment, no real cooling allowed)
Bed rooms (additional zone)	Fan coil units: ▪ In heating: 45°C ▪ In cooling: 12°C

^(a) In cooling mode, you can allow the underfloor heating (main zone) to provide refreshment (no real cooling), or NOT allow it. See setup below.

Setup

Three bizon system variations are possible:

- 1 System without hydraulic separator:

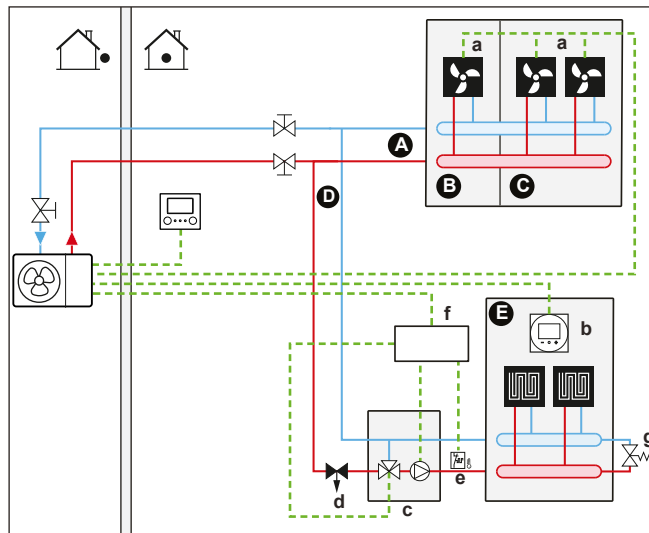

2 System with hydraulic separator for main zone:

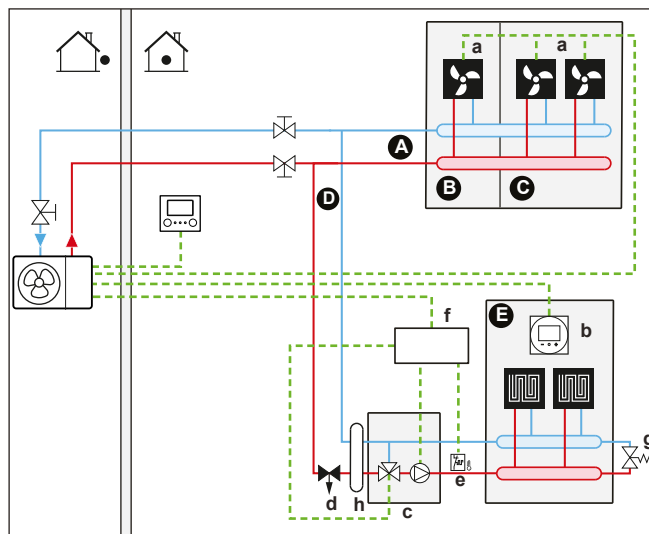

3 System with hydraulic separator for both zones:

For this system, a direct pump is required for the additional zone.

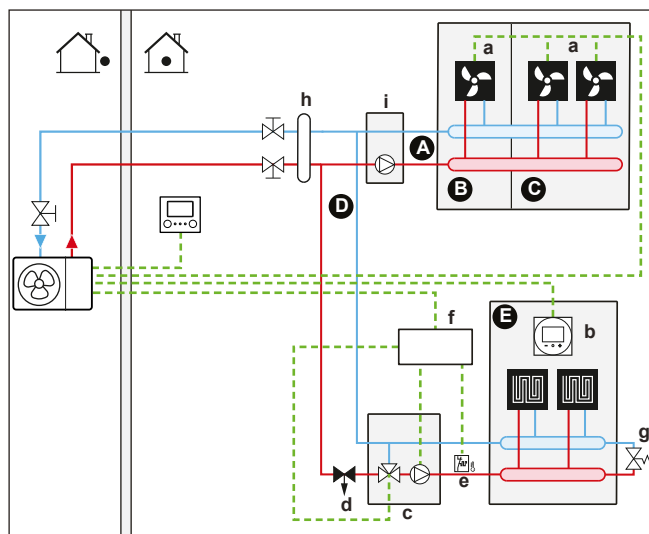

- A Additional leaving water temperature zone
- B Room 1
- C Room 2
- D Main leaving water temperature zone
- E Room 3
- a Heat pump convectors (+ controllers)

- b** Dedicated Human Comfort Interface (BRC1HHDA used as room thermostat)
- c** Mixing valve station
- d** Pressure regulating valve (field supply)
- e** Safety thermostat (field supply)
- f** Bizone kit control box (EKMIKPOA)
- g** Bypass valve
- h** Hydraulic separator (balancing bottle)
- i** Direct pump (for additional zone) (e.g. unmixed pump group EKMIKHUA)



INFORMATION

A pressure regulating valve should be implemented before the mixing valve station. This is to guarantee the correct water flow balance between the main leaving water temperature zone and the additional leaving water temperature zone in relation to the required capacity of both water temperature zones.

- A bypass valve must be installed to make water recirculation possible when all shut-off valves are closed. To guarantee reliable operation, provide a minimum water flow as described in table "To check the water volume and flow rate" in "8.1 Preparing water piping" [▶ 59].
- For the additional zone:
 - The fan coil units are directly connected to the outdoor unit – or to the backup heater, if there is one
 - The desired room temperature is set via the remote controller of the fan coil units.
 - The heating or cooling demand signals of each fan coil unit are connected in parallel to the digital input on the outdoor unit (X2M/35a and X2M/30). The outdoor unit will only supply the desired additional leaving water temperature when there is an actual demand.
- The user interface connected to the outdoor unit decides the space operation mode. Mind that the operation mode on each remote controller of the fan coil units must be set to match the outdoor unit.

Configuration

Setting	Value
Unit temperature control: ▪ #: [2.9] ▪ Code: [C-07]	2 (Room thermostat): Unit operation is decided based on the ambient temperature of the dedicated Human Comfort Interface. Note: <ul style="list-style-type: none"> ▪ Main room = dedicated Human Comfort Interface used as room thermostat functionality ▪ Other rooms = external room thermostat functionality
Number of water temperature zones: ▪ #: [4.4] ▪ Code: [7-02]	1 (Dual zone): Main + additional

Setting	Value
In case of heat pump convectors: External room thermostat for the additional zone: <ul style="list-style-type: none"> ▪ #: [3.A] ▪ Code: [C-06] 	1 (1 contact): When the used external room thermostat or heat pump convector can only send a thermo ON/OFF condition. No separation between heating or cooling demand.
Bizone kit installed: <ul style="list-style-type: none"> ▪ #: [9.P.1] ▪ Code: [E-0B] 	2 (Yes): A bizonite kit is installed in order to add an additional temperature zone.
Bizone system type: <ul style="list-style-type: none"> ▪ #: [9.P.2] ▪ Code: [E-0C] 	0 (Without hydraulic separator / no direct pump) 1 (With hydraulic separator / no direct pump) 2 (With hydraulic separator / with direct pump) (See 3 system variations described above)
Shut-off valve output	Set to follow the thermo demand of the main zone.
Shut-off valve	If the main zone must be shut off during cooling mode to prevent condensation on the floor, set it accordingly.

See "Bizone kit" [▶ 178] for more information on configuration of the bizonite kit.

Benefits

▪ **Comfort.**

- The smart room thermostat functionality can decrease or increase the desired leaving water temperature based on the actual room temperature (modulation).
- The combination of the two heat emitter systems provides the excellent heating comfort of the underfloor heating, and the excellent cooling comfort of the fan coil units.

▪ **Efficiency.**

- Depending on the demand, the outdoor unit supplies different leaving water temperature matching the design temperature of the different heat emitters.
- Underfloor heating has the best performance with the heat pump system.

6.3 Setting up an auxiliary heat source for space heating



INFORMATION

Bivalent is only possible in case of 1 leaving water temperature zone with:

- room thermostat control, OR
- external room thermostat control.

- Space heating can be done by:
 - The outdoor unit
 - An auxiliary boiler (field supply) connected to the system
- When the room thermostat requests heating, the outdoor unit or the auxiliary boiler starts operating depending on the outdoor temperature (status of the changeover to external heat source). When the permission is given to the auxiliary boiler, the space heating by the outdoor unit is turned OFF.
- Bivalent operation is only possible for space heating.



INFORMATION

- During heating operation of the heat pump, the heat pump operates to achieve the desired temperature set via the user interface. When weather-dependent operation is active, the water temperature is determined automatically depending on the outdoor temperature.
- During heating operation of the auxiliary boiler, the auxiliary boiler operates to achieve the desired water temperature set via the auxiliary boiler controller.

Setup

- Integrate the auxiliary boiler as follows:

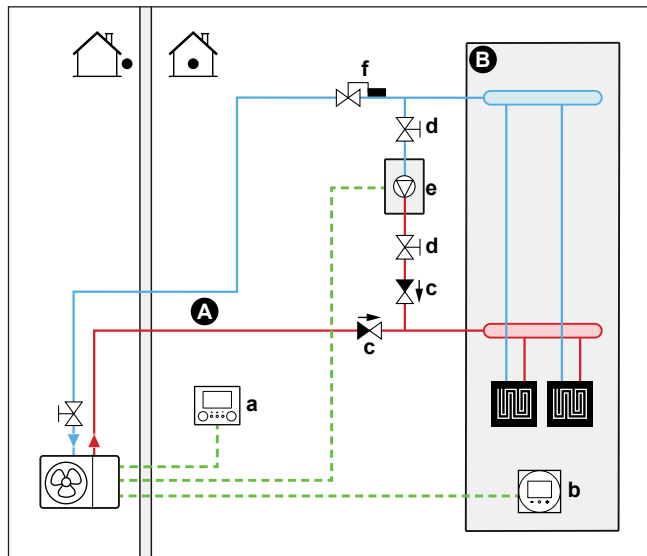

- A** Main leaving water temperature zone
- B** One single room
- a** User interface (delivered as accessory)
- b** Dedicated Human Comfort Interface (BRC1HHDA used as room thermostat)
- c** Non-return valve (field supply)
- d** Shut-off valve (field supply)
- e** Auxiliary boiler (field supply)
- f** Aquastat valve (field supply)



NOTICE

- Make sure the auxiliary boiler and its integration in the system complies with applicable legislation.
- Daikin is NOT responsible for incorrect or unsafe situations in the auxiliary boiler system.

- Make sure the return water to the heat pump does NOT exceed 60°C. To do so:
 - Set the desired water temperature via the auxiliary boiler controller to maximum 60°C.
 - Install an aquastat valve in the return water flow of the heat pump. Set the aquastat valve to close above 60°C and to open below 60°C.
- Install non-return valves.
- An expansion vessel is already pre-mounted in the outdoor unit. But for bivalent operation, also make sure that there is an expansion vessel in the auxiliary boiler loop. Otherwise when bivalent operation is running and if the Aquastat valve would close, there would be no expansion vessel in the water circuit anymore.
- Install the digital I/O PCB (option EKRP1HBAA).
- Connect X1 and X2 (changeover to external heat source) on the digital I/O PCB to the auxiliary boiler. See ["9.3.9 To connect the changeover to external heat source"](#) [▶ 96].
- To setup the heat emitters, see ["6.2 Setting up the space heating/cooling system"](#) [▶ 25].

Configuration

Via the user interface (configuration wizard):

- Set the use of a bivalent system as external heat source.
- Set the bivalent temperature and hysteresis.



NOTICE

- Make sure the bivalent hysteresis has enough differential to prevent frequent changeover between outdoor unit and auxiliary boiler.
- Because the outdoor temperature is measured by the outdoor unit air thermistor, install the outdoor unit in the shadow so that it is NOT influenced or turned ON/OFF by direct sunlight.
- Frequent changeover may cause corrosion of the auxiliary boiler. Contact the manufacturer of the auxiliary boiler for more information.

Changeover to external heat source decided by an auxiliary contact

- Only possible in external room thermostat control AND one leaving water temperature zone (see ["6.2 Setting up the space heating/cooling system"](#) [▶ 25]).
- The auxiliary contact can be:
 - An outdoor temperature thermostat
 - An electricity tariff contact
 - A manually operated contact
 - ...
- Setup: Connect the following field wiring:

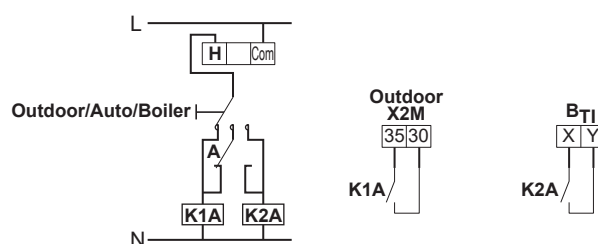

B_{T1} Boiler thermostat input
A Auxiliary contact (normally closed)

H	Heating demand room thermostat (optional)
K1A	Auxiliary relay for activation of outdoor unit (field supply)
K2A	Auxiliary relay for activation of boiler (field supply)
Outdoor	Outdoor unit
Auto	Automatic
Boiler	Boiler

Setpoint of the auxiliary gas boiler

To prevent freeze-up of the water piping, the auxiliary gas boiler must have a fixed setpoint $\geq 55^{\circ}\text{C}$, or a weather-dependent setpoint $\geq T_{\min}$.

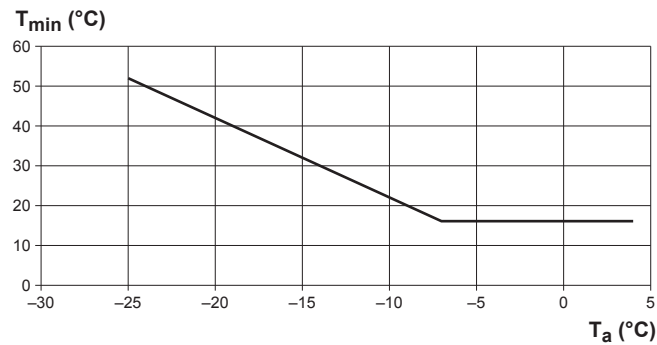

T_a Outdoor temperature
 T_{\min} Minimum weather-dependent setpoint for auxiliary gas boiler

6.4 Setting up the energy metering

- Via the user interface, you can read out the following energy data:
 - Produced heat
 - Consumed energy
- You can read out the energy data:
 - For space cooling
 - For space heating
- You can read out the energy data:
 - Per two hours (for the last 48 hours)
 - Per day (for the last 14 days)
 - Per month (for the last 24 months)
 - Total since installation



INFORMATION

The calculated produced heat and consumed energy are an estimation, the accuracy cannot be guaranteed.

6.4.1 Produced heat



INFORMATION

The sensors used to calculate the produced heat are calibrated automatically.



INFORMATION

If glycol is present in the system ([E-0D]=1)), then the produced heat will NOT be calculated, nor will it be displayed on the user interface.

- The produced heat is calculated internally based on:
 - The leaving and entering water temperature
 - The flow rate
- Setup and configuration: No additional equipment needed.

6.4.2 Consumed energy

You can use the following methods to determine the consumed energy:

- Calculating
- Measuring



INFORMATION

You cannot combine calculating the consumed energy (example: for backup heater (if applicable)) and measuring the consumed energy (example: for outdoor unit). If you do so, the energy data will be invalid.

Calculating the consumed energy

- The consumed energy is calculated internally based on:
 - The actual power input of the outdoor unit
 - The set capacity of the optional backup heater
 - The voltage
- Setup and configuration: To get accurate energy data, measure the capacity (resistance measurement) and set the capacity via the user interface for the optional backup heater (step 1 and step 2).

Measuring the consumed energy

- Preferred method because of higher accuracy.
- Requires external power meters.
- Setup and configuration: When using electrical power meters, set the number of pulses/kWh for each power meter via the user interface.



INFORMATION

When measuring the electrical power consumption, make sure ALL power input of the system is covered by the electrical power meters.

6.4.3 Power supply layouts with power meters

1 power meter. You only need 1 power meter that measures the entire system (compressor module, hydro module and backup heater) in the following cases:

- Normal kWh rate power supply
- Preferential kWh rate power supply WITHOUT separate normal kWh rate power supply

Power meter	Description
1	<p>Measures: Entire system</p> <p>Connection: X5M/5+6</p> <p>Power meter type:</p> <ul style="list-style-type: none"> Three-phase power meter in case one of the following conditions is met: <ul style="list-style-type: none"> Power supply of the external backup heater kit (if any) is 3N~ Single-phase power meter in other cases.

2 power meters. You need 2 power meters in case of preferential kWh rate power supply WITH separate normal kWh rate power supply.

Power meter	Description
1	<p>Measures^(a): Hydro module and backup heater (if any)</p> <p>Connection: X5M/5+6</p> <p>Power meter type:</p> <ul style="list-style-type: none"> Three-phase power meter in case the external backup heater kit is installed and configured to use 3N~ power supply. Single-phase power meter in other cases.
2	<p>Measures^(a): Compressor module</p> <p>Connection: X5M/3+4</p> <p>Power meter type: Single-phase power meter according to the power supply of the outdoor unit.</p>

^(a) In the software the power consumption data of both meters is added so you do NOT have to set which meter covers which power consumption.

Exceptional cases. You can also use a second power meter if:

- The power range of one meter is insufficient.
- The power meter cannot easily be installed in the electrical cabinet.
- 230 V and 400 V three-phase grids are combined (very uncommon), because of technical limitations of power meters.

Examples in case of normal kWh rate power supply

1 power meter is sufficient.

Outdoor unit (1N~) + external backup heater kit (1N~ or 3N~)

=> **b/b***: Single- or three-phase power meter (depending on external backup heater kit)

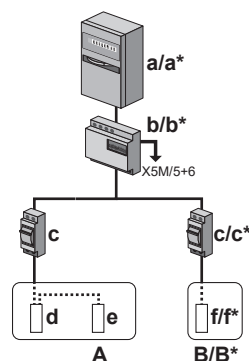

- * 3N~
- A** Outdoor unit
- B** External backup heater kit
- a** Electrical cabinet: **Normal kWh rate power supply**
- b** Power meter
- c** Overcurrent fuse
- d** Compressor module
- e** Hydro module
- f** Backup heater

Examples in case of preferential kWh rate power supply WITHOUT separate normal kWh rate power supply

1 power meter is sufficient.

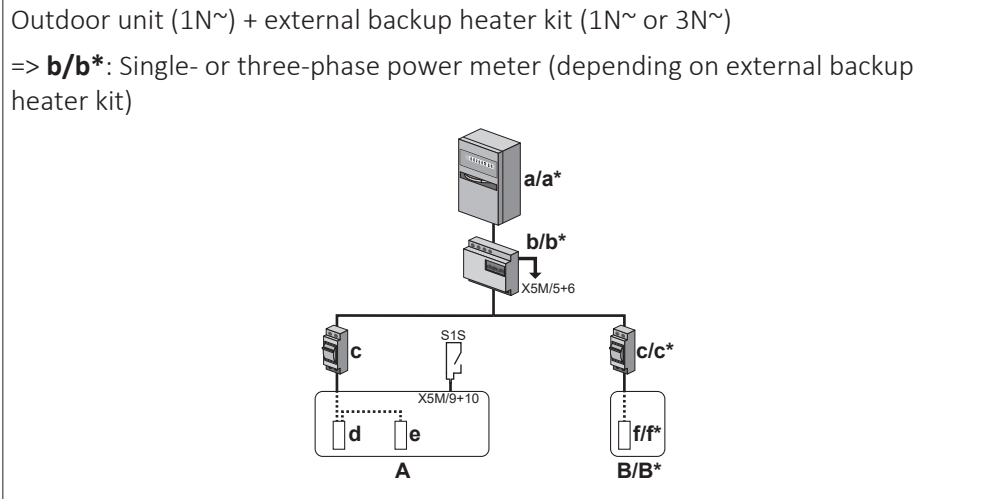

- * 3N~
- A** Outdoor unit
- B** External backup heater kit
- a** Electrical cabinet: **Preferential kWh rate power supply**
- b** Power meter
- c** Overcurrent fuse
- d** Compressor module
- e** Hydro module
- f** Backup heater
- S1S** Preferential kWh rate power supply contact

Examples in case of preferential kWh rate power supply WITH separate normal kWh rate power supply

2 power meters needed.

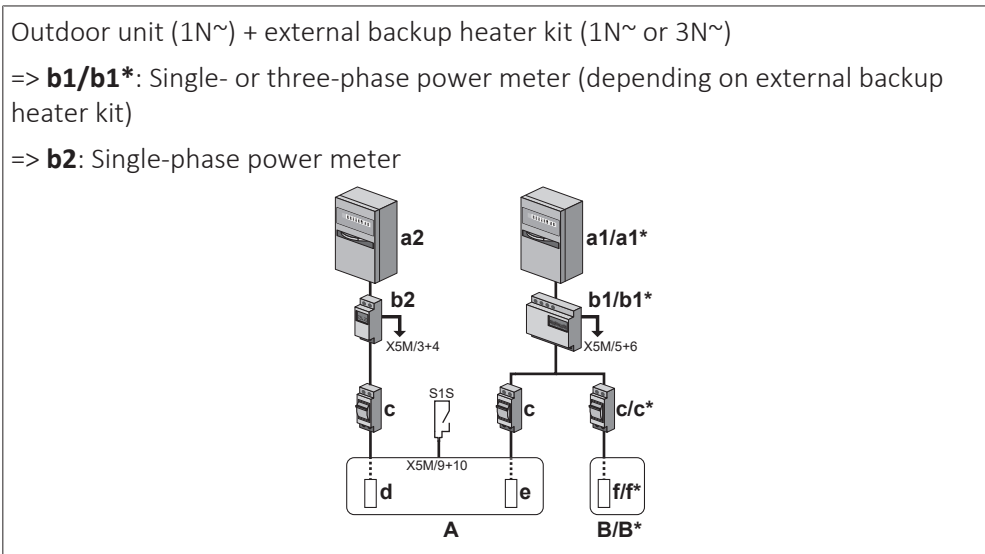

- * 3N~

- A** Outdoor unit
- B** External backup heater kit
- a1** Electrical cabinet: **Normal kWh rate power supply**
- a2** Electrical cabinet: **Preferential kWh rate power supply**
- b1** Power meter 1
- b2** Power meter 2
- c** Overcurrent fuse
- d** Compressor module
- e** Hydro module
- f** Backup heater
- S1S** Preferential kWh rate power supply contact

6.5 Setting up the power consumption control

You can use the following power consumption controls. For more information about the corresponding settings, see "[Power consumption control](#)" [▶ 169].

#	Power consumption control
1	<p>"6.5.1 Permanent power limitation" [▶ 44]</p> <ul style="list-style-type: none"> ▪ Allows you to limit the power consumption of the entire heat pump system (sum of outdoor unit and backup heater (if applicable)) with one permanent setting. ▪ Limitation of power in kW or current in A.
2	<p>"6.5.2 Power limitation activated by digital inputs" [▶ 44]</p> <ul style="list-style-type: none"> ▪ Allows you to limit the power consumption of the entire heat pump system (sum of outdoor unit and backup heater (if applicable)) via 4 digital inputs. ▪ Limitation of power in kW or current in A.
3	<p>"6.5.4 BBR16 power limitation" [▶ 46]</p> <ul style="list-style-type: none"> ▪ Restriction: Only available in Swedish language. ▪ Allows you to comply with BBR16 regulations (Swedish energy regulations). ▪ Limitation of power in kW. ▪ Can be combined with the other kW power consumption controls. If you do so, the unit uses the most restrictive control.



NOTICE

It is possible to install a field fuse with lower than recommended rating over the heat pump. For this you must modify field setting [2-0E] according to the maximum allowed current over the heat pump.

Note that field setting [2-0E] overrules all power consumption control settings. Power limiting the heat pump will reduce performance.



NOTICE

Set a minimum power consumption of ± 3.6 kW to guarantee:

- Defrost operation. Otherwise, if defrosting is interrupted several times, the heat exchanger will freeze up.
- Space heating by allowing backup heater step 1.

6.5.1 Permanent power limitation

Permanent power limitation is useful to assure a maximum power or current input of the system. In some countries, legislation limits the maximum power consumption for space heating.

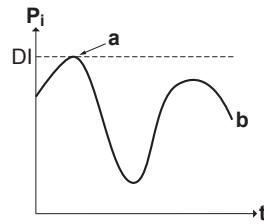

- P_i Power input
- t Time
- DI Digital input (power limitation level)
- a Power limitation active
- b Actual power input

Setup and configuration

- No additional equipment needed.
- Set the power consumption control settings in [9.9] via the user interface (see "Power consumption control" [▶ 169]):
 - Select continuous limitation mode
 - Select the type of limitation (power in kW or current in A)
 - Set the desired power limitation level

6.5.2 Power limitation activated by digital inputs

Power limitation is also useful in combination with an energy management system. The power or current of the entire Daikin system is limited dynamically by digital inputs (maximum four steps). Each power limitation level is set via the user interface by limiting one of the following:

- Current (in A)
- Power input (in kW)

The energy management system (field supply) decides the activation of a certain power limitation level. **Example:** To limit the maximum power of the entire house (lighting, domestic appliances, space heating...).

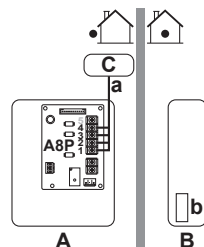

- A Outdoor unit
- B External backup heater kit
- C Energy management system
- a Power limitation activation (4 digital inputs)
- b Backup heater

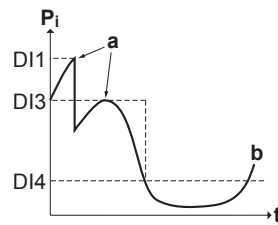

P_i Power input
t Time
DI Digital inputs (power limitation levels)
a Power limitation active
b Actual power input

Setup

- Demand PCB (option EKRP1AHTA) needed.
- Maximum four digital inputs are used to activate the corresponding power limitation level:
 - DI1 = strongest limitation (lowest energy consumption)
 - DI4 = weakest limitation (highest energy consumption)
- Specification of the digital inputs:
 - DI1: S9S (limit 1)
 - DI2: S8S (limit 2)
 - DI3: S7S (limit 3)
 - DI4: S6S (limit 4)
- Refer to the wiring diagram for more information.

Configuration

- Set the power consumption control settings in [9.9] via the user interface (for the description of all settings, see "[Power consumption control](#)" [▶ 169]):
 - Select limitation by digital inputs.
 - Select the type of limitation (power in kW or current in A).
 - Set the desired power limitation level corresponding to each digital input.



INFORMATION

In case more than 1 digital input is closed (at the same time), the digital input priority is fixed: DI4 priority>...>DI1.

6.5.3 Power limitation process

The outdoor unit has better efficiency than the backup heater. Therefore, the backup heater is limited and turned OFF first. The system limits power consumption in the following order:

- 1 Limits the backup heater.
- 2 Turns OFF the backup heater.
- 3 Limits the outdoor unit.
- 4 Turns OFF the outdoor unit.

Example

If the configuration is as follows: Power limitation level does NOT allow for backup heater operation (step 1 and step 2).

Then power consumption is limited as follows:

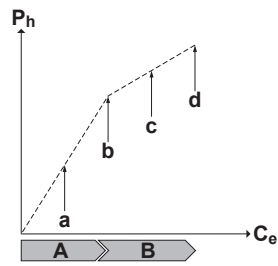

- P_h Produced heat
- C_e Consumed energy
- A** Outdoor unit
- B** Backup heater
- a** Limited outdoor unit operation
- b** Full outdoor unit operation
- c** Backup heater step 1 turned ON
- d** Backup heater step 2 turned ON

6.5.4 BBR16 power limitation



INFORMATION

Restriction: BBR16 settings are only visible when the language of the user interface is set to Swedish.



NOTICE

2 weeks to change. After you activated BBR16, you only have 2 weeks to change its settings (BBR16 activation and BBR16 power limit). After 2 weeks, the unit freezes these settings.

Note: This is different from the permanent power limitation, which is always changeable.

Use the BBR16 power limitation when you must comply with BBR16 regulations (Swedish energy regulations).

You can combine the BBR16 power limitation with the other kW power consumption controls. If you do so, the unit uses the most restrictive control.

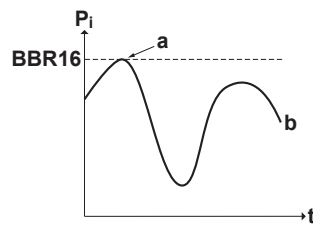

- P_i Power input
- t Time
- BBR16** BBR16 limit level
- a** Power limitation active
- b** Actual power input

Setup and configuration

- No additional equipment needed.
- Set the power consumption control settings in [9.9] via the user interface (see "Power consumption control" [▶ 169]):
 - Activate BBR16
 - Set the desired power limitation level

6.6 Setting up an external temperature sensor

You can connect one external temperature sensor. It measures the indoor or outdoor ambient temperature. We recommend to use an external temperature sensor in the following cases:

Indoor ambient temperature

- In room thermostat control, the dedicated Human Comfort Interface (BRC1HHDA used as room thermostat) measures the indoor ambient temperature. Therefore, the Human Comfort Interface must be installed on a location:
 - Where the average temperature in the room can be detected
 - That is NOT exposed to direct sunlight
 - That is NOT near a heat source
 - That is NOT affected by outside air or air draught because of, for example, door opening/closing
- If this is NOT possible, we recommend to connect a remote indoor sensor (option KRCS01-1).
- Setup: For installation instructions, see the installation manual of the remote indoor sensor, and the addendum book for optional equipment.
- Configuration: Select room sensor [9.B].

Outdoor ambient temperature

- In the outdoor unit, the outdoor ambient temperature is measured. Therefore, the outdoor unit must be installed on a location:
 - At the north side of the house or at the side of the house where the most heat emitters are located
 - That is NOT exposed to direct sunlight
- If this is NOT possible, we recommend to connect a remote outdoor sensor (option EKRSCA1).
- Setup: For installation instructions, see the installation manual of the remote outdoor sensor, and the addendum book for optional equipment.
- Configuration: Select outdoor sensor [9.B].
- When the power saving functionality of the outdoor unit is active (see "[Power saving function](#)" [▶ 177]), the outdoor unit is turned down to reduce standby energy losses. As a result, the outdoor ambient temperature is NOT read out.
- If the desired leaving water temperature is weather dependent, the full time outdoor temperature measurement is important. This is another reason to install the optional outdoor ambient temperature sensor.



INFORMATION

The external outdoor ambient sensor data (either averaged or instantaneous) is used in the weather-dependent control curves and in the automatic heating/cooling changeover logic. To protect the outdoor unit, the internal sensor of the outdoor unit is always used.

7 Unit installation

In this chapter

7.1	Preparing the installation site	48
7.1.1	Installation site requirements of the outdoor unit	48
7.1.2	Additional installation site requirements of the outdoor unit in cold climates	51
7.2	Mounting the outdoor unit	52
7.2.1	About mounting the outdoor unit	52
7.2.2	Precautions when mounting the outdoor unit	52
7.2.3	To provide the installation structure	52
7.2.4	To install the outdoor unit	53
7.2.5	To provide drainage	55
7.3	Opening and closing the unit	56
7.3.1	About opening the units	56
7.3.2	To open the outdoor unit	56
7.3.3	To rotate the switch box	57
7.3.4	To close the outdoor unit	58

7.1 Preparing the installation site

Choose an installation location with sufficient space to transport the unit in and out of the site.

Do NOT install the unit in places often used as work place. In case of construction works (e.g. grinding works) where a lot of dust is created, the unit MUST be covered.



WARNING

The appliance shall be stored so as to prevent mechanical damage and in a well-ventilated room without continuously operating ignition sources (example: open flames, an operating gas appliance or an operating electric heater).

7.1.1 Installation site requirements of the outdoor unit



INFORMATION

Also read the precautions and requirements in the "[2 General safety precautions](#)" [▶ 9].

Mind the following spacing guidelines:

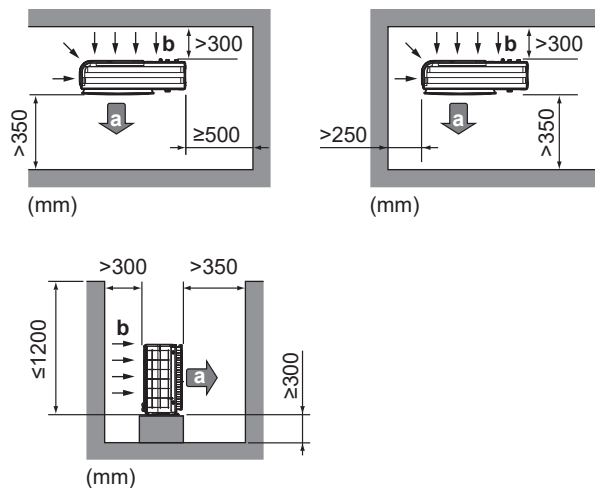

a Air outlet

b Air inlet

**NOTICE**

- Do NOT stack the units on each other.
- Do NOT hang the unit on a ceiling.

Strong winds (≥ 18 km/h) blowing against the outdoor unit's air outlet causes short circuit (suction of discharge air). This may result in:

- deterioration of the operational capacity;
- frequent frost acceleration in heating operation;
- disruption of operation due to decrease of low pressure or increase of high pressure;
- a broken fan (if a strong wind blows continuously on the fan, it may start rotating very fast, until it breaks).

It is recommended to install a baffle plate when the air outlet is exposed to wind.

It is recommended to install the outdoor unit with the air inlet facing the wall and NOT directly exposed to the wind.

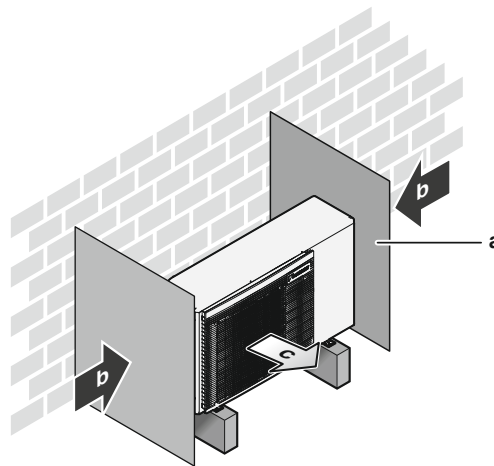

- a Baffle plate
- b Prevailing wind direction
- c Air outlet

Do NOT install the unit in the following places:

- Sound sensitive areas (e.g. near a bedroom), so that the operation noise will cause no trouble.

Note: If the sound is measured under actual installation conditions, the measured value might be higher than the sound pressure level mentioned in Sound spectrum in the data book due to environmental noise and sound reflections.

- In places where a mineral oil mist, spray or vapour may be present in the atmosphere. Plastic parts may deteriorate and fall off or cause water leakage.

It is NOT recommended to install the unit in the following places because it may shorten the life of the unit:

- Where the voltage fluctuates a lot
- In vehicles or vessels
- Where acidic or alkaline vapour is present

Seaside installation. Make sure the outdoor unit is NOT directly exposed to sea winds. This is to prevent corrosion caused by high levels of salt in the air, which might shorten the life of the unit.

Install the outdoor unit away from direct sea winds.

Example: Behind the building.

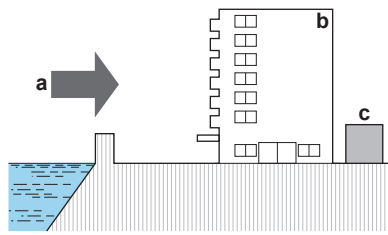

If the outdoor unit is exposed to direct sea winds, install a windbreaker.

- Height of windbreaker $\geq 1.5 \times$ height of outdoor unit
- Mind the service space requirements when installing the windbreaker.

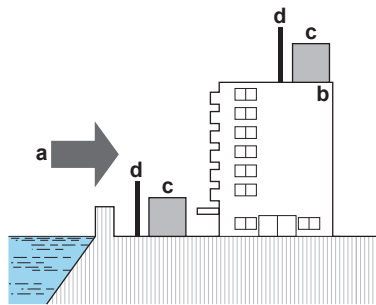

- a Sea wind
- b Building
- c Outdoor unit
- d Windbreaker

The outdoor unit is designed for outdoor installation only, and for the following ambient temperatures:

Cooling mode	10~43°C
Heating mode	-25~25°C

Mind the measurement guidelines:

Maximum distance between outdoor unit and external backup heater kit	10 m
--	------

Special requirements for R32

The outdoor unit contains an internal refrigerant circuit (R32), but you do NOT have to do any refrigerant field piping, or refrigerant charging.

Mind the following requirements and precautions:



WARNING

- Do NOT pierce or burn refrigerant cycle parts.
- Do NOT use means to accelerate the defrosting process or to clean the equipment, other than those recommended by the manufacturer.
- Be aware that R32 refrigerant does NOT contain an odour.



WARNING

The appliance shall be stored so as to prevent mechanical damage and in a well-ventilated room without continuously operating ignition sources (example: open flames, an operating gas appliance or an operating electric heater).

**WARNING**

Make sure installation, servicing, maintenance and repair comply with instructions from Daikin and with applicable legislation and are executed **ONLY** by authorised persons.

7.1.2 Additional installation site requirements of the outdoor unit in cold climates

In areas with low ambient temperatures and high humidity, or in areas with heavy snowfall, remove the suction grille to ensure proper operation.

Non-exhaustive list of areas: Austria, Czech Republic, Denmark, Estonia, Finland, Germany, Hungary, Latvia, Lithuania, Norway, Poland, Romania, Serbia, Slovakia, Sweden, ...

- 1 Remove the screws holding the suction grille.
- 2 Remove the suction grille, and dispose of it.
- 3 Reattach the screws to the unit.

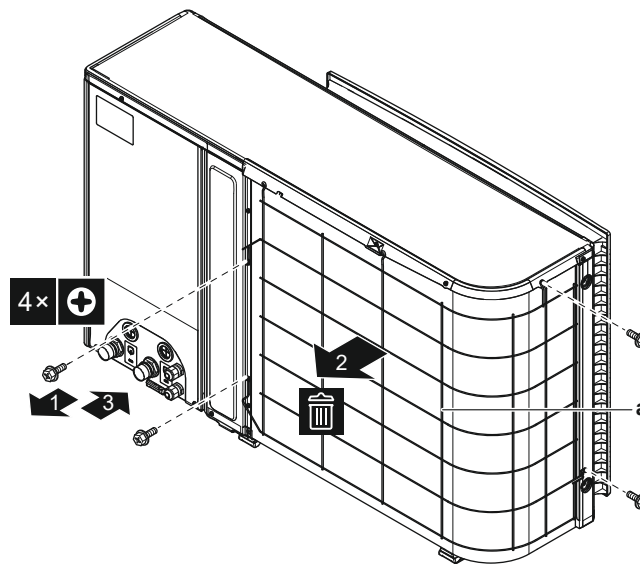

a Suction grille

Protect the outdoor unit against direct snowfall and take care that the outdoor unit is **NEVER** snowed up.

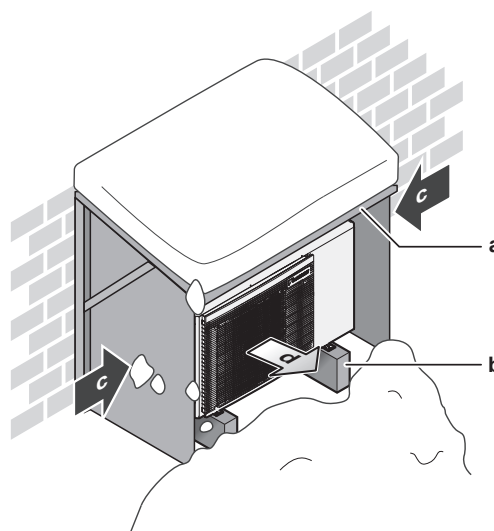

a Snow cover or shed
b Pedestal
c Prevailing wind direction

d Air outlet

In any case, provide at least 300 mm of free space below the unit. Additionally, make sure the unit is positioned at least 100 mm above the maximum expected level of snow. See "[7.2 Mounting the outdoor unit](#)" [[▶ 52](#)] for more details.

In heavy snowfall areas it is very important to select an installation site where the snow will NOT affect the unit. If lateral snowfall is possible, make sure that the heat exchanger coil is NOT affected by the snow. If necessary, install a snow cover or shed and a pedestal.

7.2 Mounting the outdoor unit

7.2.1 About mounting the outdoor unit

When

You have to mount the outdoor unit before you can connect the water piping.

Typical workflow

Mounting the outdoor unit typically consists of the following stages:

- 1 Providing the installation structure.
- 2 Installing the outdoor unit.
- 3 Providing drainage.
- 4 Preventing the unit from falling over.
- 5 Protecting the unit against snow and wind by installing a snow cover and baffle plates. See "[7.1 Preparing the installation site](#)" [[▶ 48](#)].

7.2.2 Precautions when mounting the outdoor unit



INFORMATION

Also read the precautions and requirements in the following chapters:

- "[2 General safety precautions](#)" [[▶ 9](#)]
- "[7.1 Preparing the installation site](#)" [[▶ 48](#)]

7.2.3 To provide the installation structure

Check the strength and level of the installation ground so that the unit will not cause any operating vibration or noise.

Fix the unit securely by means of foundation bolts in accordance with the foundation drawing.

This topic shows different installation structures. For all, use 4 sets of M8 or M10 anchor bolts, nuts and washers. In any case, provide at least 300 mm of free space below the unit. Additionally, make sure the unit is positioned at least 100 mm above the maximum expected level of snow.



INFORMATION

The maximum height of the upper protruding part of the bolts is 15 mm.

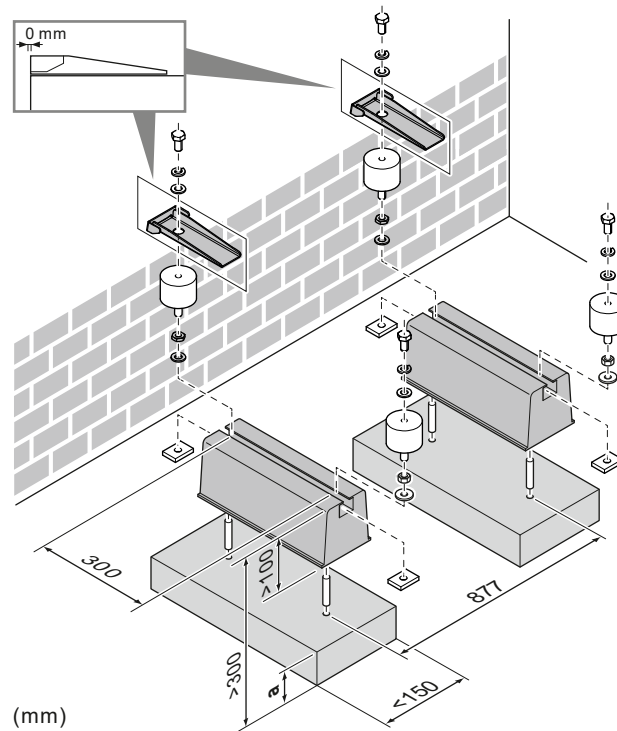
Option 1: On mounting feet "flexi-foot with strut"

a Maximum snowfall height

Option 2: On plastic mounting feet

In this case, you can use the bolts, nuts, washers and spring washers delivered with the unit as accessories.

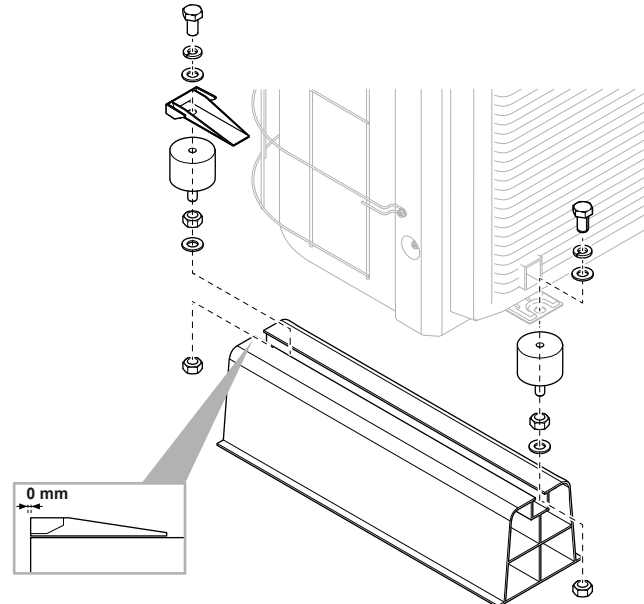

7.2.4 To install the outdoor unit

**CAUTION**

To avoid injury, do NOT touch the air inlet or aluminium fins of the unit.

**CAUTION**

Do NOT remove the protective cardboard before the unit is installed properly.

- 1 Carry the unit using the slings attached to the unit. Pull up both sides of the sling at the same time to prevent disconnection of the sling from the unit.

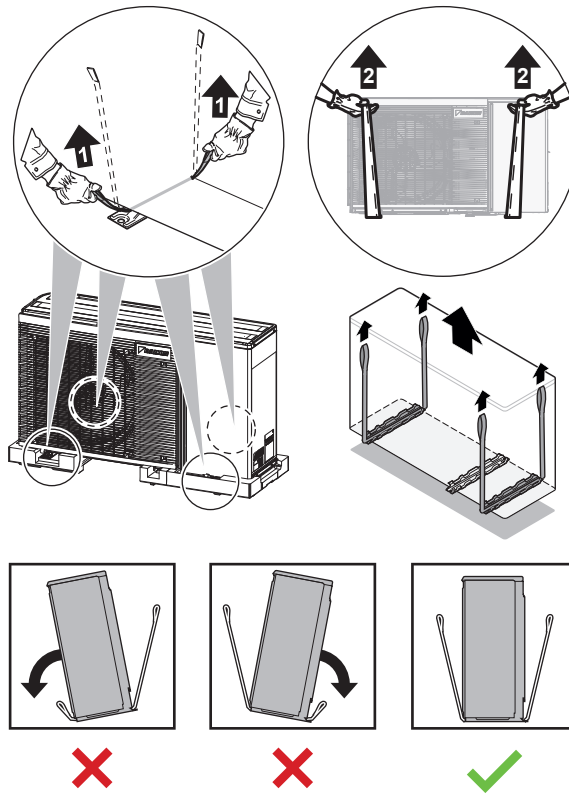

- 2 While handling the unit:
 - Keep both sides of the sling level.
 - Keep your back straight.

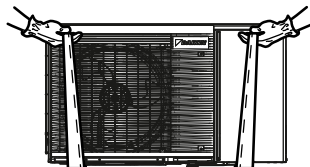

- 3 Install the outdoor unit as follows:
 - (1) Put the unit into position.
 - (2) Remove the slings (by pulling 1 side of the sling).
 - (3) Fix the unit.

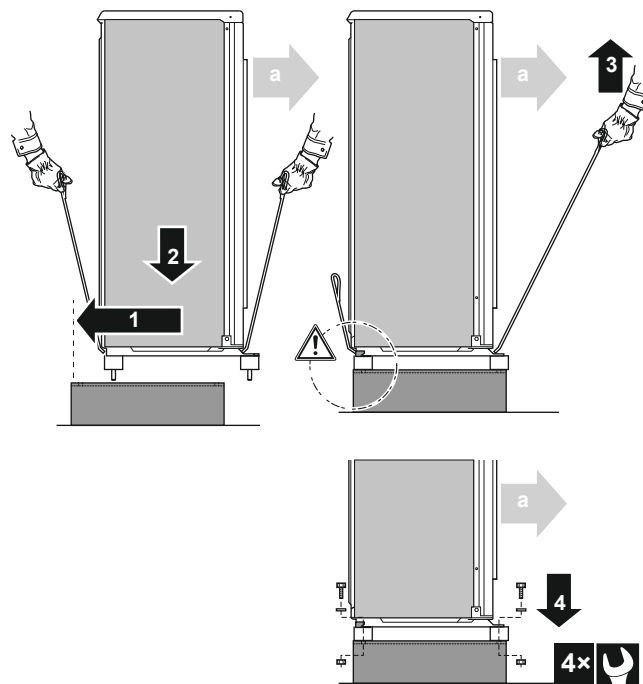

a Air outlet



NOTICE

Properly align the unit. Make sure the backside of the unit does NOT protrude.

- 4 Remove the protective cardboard and instruction sheet.

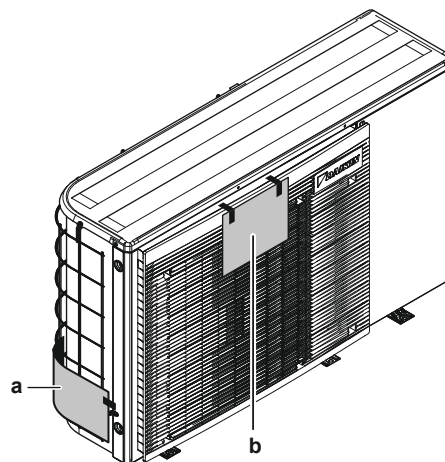

a Protective cardboard
b Instruction sheet

7.2.5 To provide drainage

- Make sure that condensation water can be evacuated properly.
- Install the unit on a base to make sure that there is proper drainage in order to avoid ice accumulation.
- Prepare a water drainage channel around the foundation to drain waste water away from the unit.
- Avoid drain water flowing over the footpath, so that it does NOT become slippery in case of ambient freezing temperatures.

- If you install the unit on a frame, install a waterproof plate within 150 mm of the bottom side of the unit in order to prevent water from getting into the unit and to avoid drain water dripping (see the following figure).



INFORMATION

If necessary, you can use a drain pan (field supply) to prevent drain water from dripping.



NOTICE

If the drain holes of the outdoor unit are blocked up, provide space of at least 300 mm below the outdoor unit.



NOTICE

If the unit CANNOT be installed fully level, always make sure that the inclination is towards the backside of the unit. This is required to guarantee proper drainage.

7.3 Opening and closing the unit

7.3.1 About opening the units

At certain times, you have to open the unit. **Example:**

- When connecting the electrical wiring
- When maintaining or servicing the unit



DANGER: RISK OF ELECTROCUTION

Do NOT leave the unit unattended when the service cover is removed.

7.3.2 To open the outdoor unit



DANGER: RISK OF ELECTROCUTION



DANGER: RISK OF BURNING/SCALDING

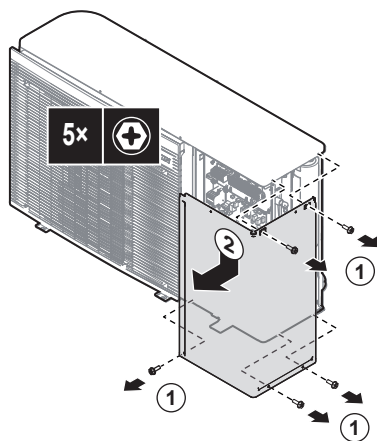

7.3.3 To rotate the switch box

During the installation, you will need access to the inside of the outdoor unit. To have easier front access, rotate the switch box out of the unit as follows:

Prerequisite: The front plate has been removed.

- 1 Push down the clip of the switch box holder.

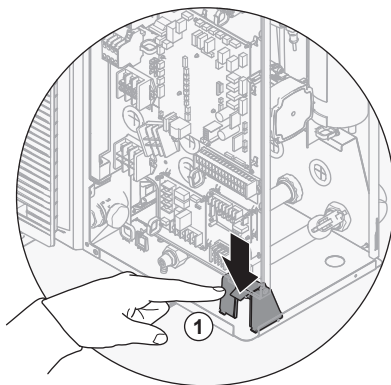

- 2 Rotate the switch box out of the unit.

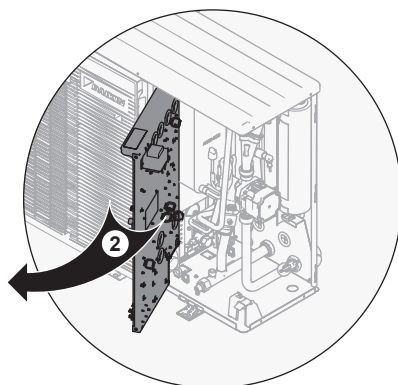

- 3 Rotate the switch box back until it engages properly in the switch box holder.

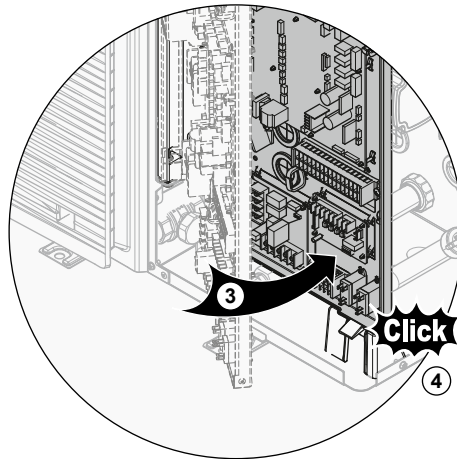

7.3.4 To close the outdoor unit



NOTICE

Speed nut. Make sure the speed nut for the top screw is correctly attached to the service cover.

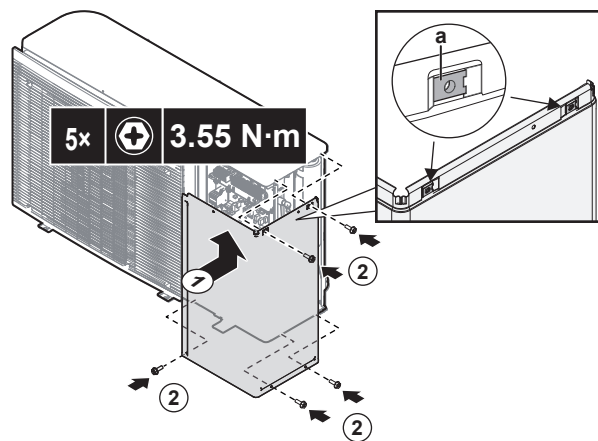

a Speed nut

8 Piping installation

In this chapter

8.1	Preparing water piping	59
8.1.1	Water circuit requirements	59
8.1.2	Formula to calculate the expansion vessel pre-pressure	61
8.1.3	To check the water volume and flow rate	61
8.1.4	Changing the pre-pressure of the expansion vessel	64
8.1.5	To check the water volume: Examples	64
8.2	Connecting water piping	65
8.2.1	About connecting the water piping	65
8.2.2	Precautions when connecting the water piping	65
8.2.3	To connect the water piping	66
8.2.4	To protect the water circuit against freezing	67
8.2.5	To fill the water circuit	70
8.2.6	To insulate the water piping	71

8.1 Preparing water piping

8.1.1 Water circuit requirements



INFORMATION

Also read the precautions and requirements in the "[2 General safety precautions](#)" [▶ 9].



NOTICE

In case of plastic pipes, make sure they are fully oxygen diffusion tight according to DIN 4726. The diffusion of oxygen into the piping can lead to excessive corrosion.

- **Connecting piping – Legislation.** Make all piping connections in accordance with the applicable legislation and the instructions in the "Installation" chapter, respecting the water inlet and outlet.
- **Connecting piping – Force.** Do NOT use excessive force when connecting the piping. Deformation of the piping can cause malfunctioning of the unit.
- **Connecting piping – Tools.** Only use appropriate tooling to handle brass, which is a soft material. If NOT, pipes will get damaged.
- **Connecting piping – Air, moisture, dust.** If air, moisture or dust gets into the circuit, problems may occur. To prevent this:
 - ONLY use clean pipes.
 - Hold the pipe end downwards when removing burrs.
 - Cover the pipe end when inserting it through a wall, to prevent dust and/or particles from entering the pipe.
 - Use a decent thread sealant to seal connections.
 - When using non-brass metallic piping, make sure to insulate both materials from each other to prevent galvanic corrosion.
 - Because brass is a soft material, use appropriate tooling for connecting the water circuit. Inappropriate tooling will cause damage to the pipes.
- **Freeze.** Protect against freezing.
- **Closed circuit.** Use the indoor unit ONLY in a closed water system. Using the system in an open water system will lead to excessive corrosion.

- **Piping diameter.** Select the water piping diameter in relation to the required water flow and the available external static pressure of the pump.

For the external static pressure curves of the outdoor unit, see the technical data. A **subset** of the latest technical data is available on the regional Daikin website (publicly accessible). The **full set** of latest technical data is available on the Daikin Business Portal (authentication required).

- **Water flow.** You can find the minimum required water flow for unit operation in the following table. In all cases, this flow needs to be guaranteed. When the flow is lower, the unit will stop operation and display error 7H.

If operation is...	Then the minimum required flow rate is...
Cooling	10 l/min
Heating	6 l/min
BUH operation	12 l/min
Heating defrost	12 l/min

- **Field supply components – Water and glycol.** Only use materials that are compatible with the water (and, if applicable, glycol) used in the system, and with the materials used in the outdoor unit.
- **Field supply components – Water pressure and temperature.** Check that all components in the field piping can withstand the water pressure and water temperature.
- **Water pressure.** The maximum water pressure is 4 bar. Provide adequate safeguards in the water circuit to ensure that the maximum pressure is NOT exceeded.
- **Water temperature.** All installed piping and piping accessories (valve, connections,...) MUST withstand the following temperatures:



INFORMATION

The following figure is an example and may NOT completely match your system layout

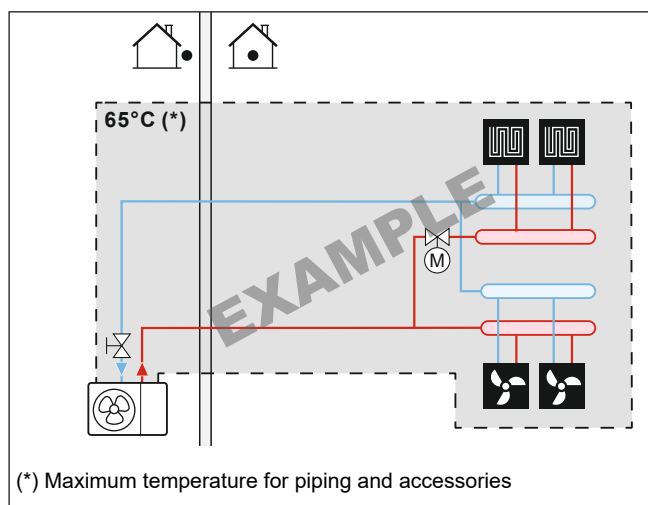

- **Drainage – Low points.** Provide drain taps at all low points of the system in order to allow complete drainage of the water circuit.

- **Air vents.** Provide air vents at all high points of the system, which must also be easily accessible for servicing.

The outdoor unit has an automatic air purge valve.

The external backup heater kit (option) has an automatic air purge valve.

Check that the automatic air purge valves are NOT tightened too much, so that the automatic release of air from the water circuit is possible.

- **Zn-coated parts.** NEVER use zinc coated parts in the water circuit. Because the internal water circuit of the unit uses copper piping, excessive corrosion may occur.
- **Non-brass metallic piping.** When using non-brass metallic piping, insulate the brass and non-brass properly so that they do NOT make contact with each other. This to prevent galvanic corrosion.
- **Valve – Change-over time.** When using a 2-way valve or a 3-way valve in the water circuit, the maximum change-over time of the valve must be 60 seconds.
- **Filter.** It is strongly recommended to install an additional filter on the heating water circuit. Especially to remove metallic particles from foul heating piping, it is recommended to use a magnetic or cyclone filter, which can remove small particles. Small particles may damage the unit and will NOT be removed by the standard filter of the heat pump system.
- **Thermostatic mixing valves.** In accordance with the applicable legislation, it may be necessary to install thermostatic mixing valves.
- **Hygienic measures.** The installation must be in compliance with the applicable legislation and may require additional hygienic installation measures.

8.1.2 Formula to calculate the expansion vessel pre-pressure

The pre-pressure (Pg) of the vessel depends on the installation height difference (H):

$$Pg=0.3+(H/10) \text{ (bar)}$$

8.1.3 To check the water volume and flow rate

The outdoor unit has an expansion vessel of 7 litre with a factory-set pre-pressure of 1 bar.

To make sure that the unit operates properly:

- You MUST check the minimum and maximum water volume.
- You might need to adjust the pre-pressure of the expansion vessel.

Minimum water volume

Check that the total water volume in the installation is higher than the minimum water volume, the internal water volume of the outdoor unit NOT included:

If...	Then the minimum water volume is...
Cooling operation	15 l
Heating/defrost operation and the external backup heater kit is...	

If...		Then the minimum water volume is...
	Connected	15 l
	NOT connected and...	
	The return flow temperature is $>15^{\circ}\text{C}$	20 l
	The return flow temperature is $\leq 15^{\circ}\text{C}$	50 l



INFORMATION

In critical processes, or in rooms with a high heat load, extra water might be required.



NOTICE

Never use less water than the minimum water volume. It may cause the unit to malfunction.



NOTICE

When circulation in each space heating/cooling loop is controlled by remotely controlled valves, it is important that the minimum water volume is guaranteed, even if all of the valves are closed or the overpressure bypass valve is installed in front of the space heating/cooling loop.

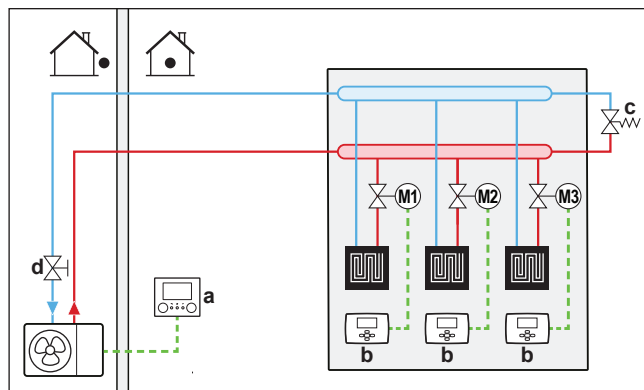

- a User interface (delivered as accessory)
- b Individual room thermostat (option)
- c Differential pressure bypass valve (field supply)
- d Shut-off valve (delivered as accessory)
- M1...3 Individual motorised valve to control each loop (field supply)

Maximum water volume



NOTICE

The maximum water volume depends on whether glycol is added to the water circuit. For more information on the addition of glycol, refer to "8.2.4 To protect the water circuit against freezing" [▶ 67].

Use the following graph to determine the maximum water volume for the calculated pre-pressure.

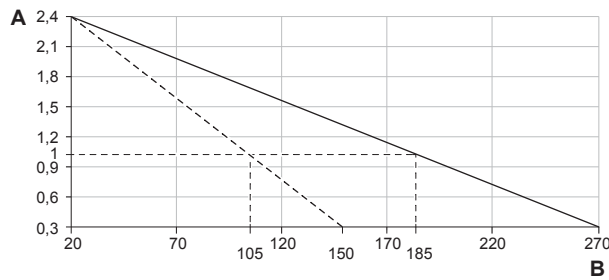

A Pre-pressure (bar)
B Maximum water volume (l)
 — Water
 - - - Water + glycol

Example: Maximum water volume and expansion vessel pre-pressure

Installation height difference ^(a)	Water volume	
	≤185/105 l ^(b)	>185/105 l ^(b)
≤7 m	No pre-pressure adjustment is required.	Do the following: <ul style="list-style-type: none"> Decrease the pre-pressure according to the required installation height difference. The pre-pressure should decrease by 0.1 bar for each metre below 7 m. Check if the water volume does NOT exceed the maximum allowed water volume.
>7 m	Do the following: <ul style="list-style-type: none"> Increase the pre-pressure according to the required installation height difference. The pre-pressure should increase by 0.1 bar for each metre above 7 m. Check if the water volume does NOT exceed the maximum allowed water volume. 	The expansion vessel of the outdoor unit is too small for the installation. In this case, it is recommended to install an extra vessel outside the unit.

^(a) This is the height difference (m) between the highest point of the water circuit and the outdoor unit. If the outdoor unit is at the highest point of the installation, the installation height is 0 m.

^(b) The maximum water volume is 185 l in case the circuit is only filled with water, and 105 l in case the circuit is filled with water and glycol.

Minimum flow rate

Check that the minimum flow rate (required during defrost/backup heater operation (if applicable)) in the installation is guaranteed in all conditions.

If operation is...	Then the minimum required flow rate is...
Cooling	10 l/min
Heating	6 l/min

If operation is...	Then the minimum required flow rate is...
BUH operation	12 l/min
Heating defrost	12 l/min

**NOTICE**

If glycol was added to the water circuit, and the temperature of the water circuit is low, the flow rate will NOT be displayed on the user interface. In this case, the minimum flow rate can be checked by way of the pump test.

**NOTICE**

When circulation in each or certain space heating loops is controlled by remotely controlled valves, it is important that the minimum flow rate is guaranteed, even if all valves are closed. In case the minimum flow rate cannot be reached, a flow error 7H will be generated (no heating or operation).

See the recommended procedure as described in "[11.4 Checklist during commissioning](#)" [▶ 188].

8.1.4 Changing the pre-pressure of the expansion vessel

**NOTICE**

ONLY a licensed installer may adjust the pre-pressure of the expansion vessel.

The default pre-pressure of the expansion vessel is 1 bar. When it is required to change the pre-pressure, take following guidelines into account:

- Only use dry nitrogen to set the expansion vessel pre-pressure.
- Inappropriate setting of the expansion vessel pre-pressure will lead to malfunction of the system.

Changing the pre-pressure of the expansion vessel should be done by releasing or increasing nitrogen pressure through the Schrader valve of the expansion vessel.

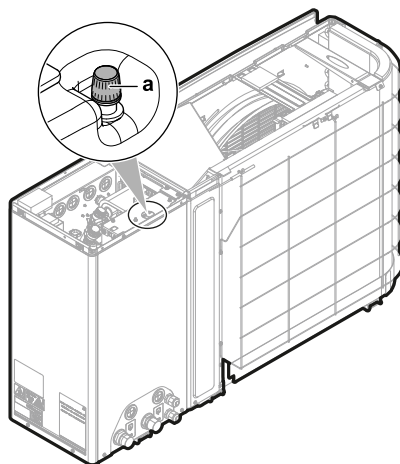

a Schrader valve

8.1.5 To check the water volume: Examples

Example 1

The outdoor unit is installed 5 m below the highest point in the water circuit. The total water volume in the water circuit is 100 l.

No actions or adjustments are required.

Example 2

The outdoor unit is installed at the highest point in the water circuit. The total water volume in the water circuit is 250 l.

Actions:

- Because the total water volume (250 l) is more than the default water volume (185 l), the pre-pressure must be decreased.
- The required pre-pressure is:

$$P_g = (0.3 + (H/10)) \text{ bar} = (0.3 + (0/10)) \text{ bar} = 0.3 \text{ bar}$$
- The corresponding maximum water volume at 0.3 bar is 270 l. (See the graph in "[Maximum water volume](#)" [[▶ 62](#)]).
- Because 250 l is lower than 270 l, the expansion vessel is appropriate for the installation.

8.2 Connecting water piping

8.2.1 About connecting the water piping

Before connecting the water piping

Typical workflow

Connecting the water piping typically consists of the following stages:

- 1 Connecting the water piping of the outdoor unit.
- 2 Connecting the water piping of the external backup heater kit (if applicable).
- 3 Protecting the water circuit against freezing (addition of glycol or installation of freeze protection valves).
- 4 Filling the water circuit.
- 5 Insulating the water piping.



INFORMATION

For instructions regarding the external backup heater kit, see:

- The installation manual of the backup heater kit
- "[To connect the backup heater kit](#)" [[▶ 83](#)] (this topic partially supersedes the installation manual of the backup heater)

8.2.2 Precautions when connecting the water piping



INFORMATION

Also read the precautions and requirements in the following chapters:

- "[2 General safety precautions](#)" [[▶ 9](#)]
- "[8.1 Preparing water piping](#)" [[▶ 59](#)]

8.2.3 To connect the water piping



NOTICE

Do NOT use excessive force when connecting the field piping and make sure the piping is aligned properly. Deformation of the piping can cause malfunctioning of the unit.



NOTICE

When connecting the field piping, hold the nut on the inside of the unit in place using a spanner to provide extra leverage.

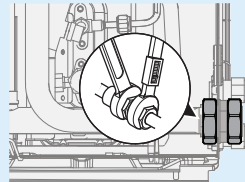

- 1 Connect the shut-off valve (with integrated filter) to the outdoor unit water inlet, using thread sealant.

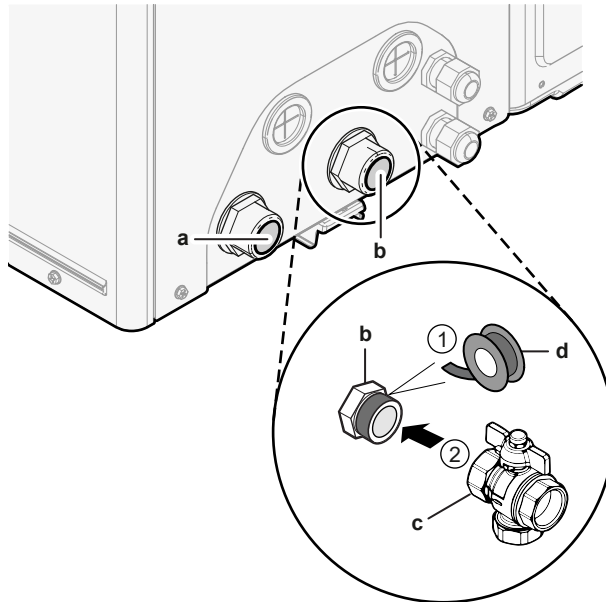

- a Water OUT (screw connection, male, 1")
- b Water IN (screw connection, male, 1")
- c Shut-off valve with integrated filter (delivered as accessory)(2× screw connection, female, 1")
- d Thread sealant

- 2 Connect the field piping to the shut-off valve.
- 3 Connect the field piping to the outdoor unit water outlet.



NOTICE

About the shut-off valve with integrated filter (delivered as accessory):

- The installation of the valve at the water inlet is mandatory.
- Mind the flow direction of the valve.

**NOTICE**

For service purposes, it is recommended to also install a shut-off valve and drain point to the water OUT connection. This shut-off valve and drain point are field supplied.

**NOTICE**

Install air purge valves at all local high points.

8.2.4 To protect the water circuit against freezing

About freeze protection

Frost can damage the system. To prevent the hydraulic components from freezing, the software is equipped with special frost protection functions, that include the activation of pump in case of low temperatures:

- Water pipe freeze prevention (see "[Water pipe freeze prevention](#)" [▶ 165]),
- Drain prevention. Only applicable when **Bivalent** is enabled ([C-02]=1). This function prevents the opening of freeze protection valves in the water piping to the outdoor unit when the auxiliary boiler is running at negative outdoor temperatures.

However, in case of a power failure, these functions cannot guarantee protection.

Do one of the following to protect the water circuit against freezing:

- Add glycol to the water. Glycol lowers the freezing point of the water.
- Install freeze protection valves. Freeze protection valves drain the water from the system before it can freeze. Insulate the freeze protection valves in a similar way as the water piping, but do NOT insulate the inlet and outlet (release) of these valves.

**NOTICE**

If you add glycol to the water, do NOT install freeze protection valves. **Possible consequence:** Glycol leaking out of the freeze protection valves.

**NOTICE**

If you add glycol to the water, you also need to install a flow switch (EKFLSW2).

Freeze protection by glycol

About freeze protection by glycol

Adding glycol to the water lowers the freezing point of water.

**WARNING**

Ethylene glycol is toxic.



WARNING

Due to the presence of glycol, corrosion of the system is possible. Uninhibited glycol will turn acidic under the influence of oxygen. This process is accelerated by the presence of copper and high temperatures. The acidic uninhibited glycol attacks metal surfaces and forms galvanic corrosion cells that cause severe damage to the system. Therefore it is important that:

- the water treatment is correctly executed by a qualified water specialist,
- a glycol with corrosion inhibitors is selected to counteract acids formed by the oxidation of glycols,
- no automotive glycol is used because their corrosion inhibitors have a limited lifetime and contain silicates which can foul or plug the system,
- galvanized pipes are NOT used in glycol systems since the presence may lead to the precipitation of certain components in the glycol's corrosion inhibitor.



NOTICE

Glycol absorbs water from its environment. Therefore do NOT add glycol that has been exposed to air. Leaving the cap off the glycol container causes the concentration of water to increase. The glycol concentration is then lower than assumed. As a result, the hydraulic components might freeze up after all. Take preventive actions to ensure a minimal exposure of the glycol to air.

Types of glycol

The following types of glycol are allowed:

- **Ethylene glycol;**
- **Propylene glycol**, including the necessary inhibitors, classified as Category III according to EN1717.

Required concentration of glycol

The required concentration of glycol depends on the lowest expected outdoor temperature, and on whether you want to protect the system from bursting or from freezing. To prevent the system from freezing, more glycol is required.

Add glycol according to the table below.

Lowest expected outdoor temperature	Prevent from bursting	Prevent from freezing
-5°C	10%	15%
-10°C	15%	25%
-15°C	20%	35%
-20°C	25%	—
-25°C	30%	—
-30°C	35%	—



INFORMATION

- Protection against bursting: the glycol will prevent the piping from bursting, but NOT the liquid inside the piping from freezing.
- Protection against freezing: the glycol will prevent the liquid inside the piping from freezing.

**NOTICE**

- The required concentration might differ depending on the type of glycol. ALWAYS compare the requirements from the table above with the specifications provided by the glycol manufacturer. If necessary, meet the requirements set by the glycol manufacturer.
- The added concentration of glycol should NEVER exceed 35%.
- If the liquid in the system is frozen, the pump will NOT be able to start. Mind that if you only prevent the system from bursting, the liquid inside might still freeze.
- When water is at standstill inside the system, the system is very likely to freeze and get damaged.

Glycol and the maximum allowed water volume

Adding glycol to the water circuit reduces the maximum allowed water volume of the system. For more information, see "[Maximum water volume](#)" [▶ 62].

Glycol setting**NOTICE**

If glycol is present in the system, setting [E-OD] must be set to 1. If the glycol setting is NOT set correctly, the liquid inside the piping can freeze.

Freeze protection by freeze protection valves**About freeze protection valves**

It is the responsibility of the installer to protect the field piping against freezing. When no glycol is added to the water, you can use freeze protection valves at all lowest points of the field piping to drain the water from the system before it can freeze.

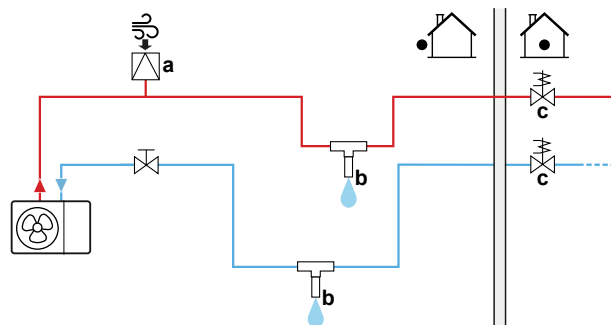

To install freeze protection valves

To protect the field piping against freezing, install the following parts:

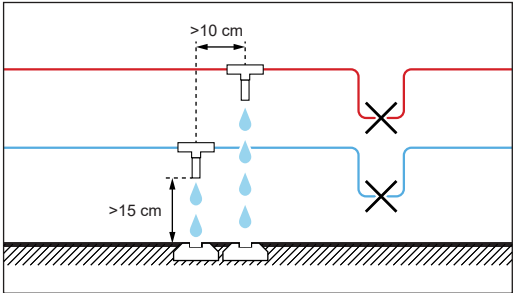

- a Automatic air intake
- b Freeze protection valve (optional – field supply)
- c Normally closed valves (recommended – field supply)

Part	Description
	An automatic air intake (for air supply) should be installed at the highest point. For example, an automatic air purge.

Part	Description
	<p>Protection for the field piping.</p> <ul style="list-style-type: none"> ▪ Install the freeze protection valves: <ul style="list-style-type: none"> - At all lowest points of the field piping. - In the coldest part of the field piping, away from heat sources. - Vertically to allow water to flow out properly. - >15 cm above the ground to prevent ice from blocking the water exit. Make sure there are no obstructions. - >10 cm away from other freeze protection valves. ▪ Prevent rain, snow and direct sunlight on the freeze protection valves. ▪ Insulate the freeze protection valves in a similar way as the water piping, but do NOT insulate the inlet and outlet (release) of these valves. ▪ Do NOT make traps in the field piping. 
	<p>Isolation of water inside the house when there is a power interruption. Normally closed valves (located indoors near the piping entry/exit points) can prevent that all water from indoor piping is drained when the freeze protection valves open.</p> <ul style="list-style-type: none"> ▪ When there is a power interruption: The normally closed valves close and isolate the water inside the house. If the freeze protection valves open, only the water outside the house is drained. ▪ In other circumstances (example: when there is a pump failure): The normally closed valves remain open. If the freeze protection valves open, the water from inside the house is also drained.



NOTICE

When freeze protection valves are installed, set the minimum cooling setpoint (default=7°C) at least 2°C higher than the maximum opening temperature of the freeze protection valve. If lower, freeze protection valves can open during cooling operation.

8.2.5 To fill the water circuit

To fill the water circuit, use a field supply filling kit. Make sure you comply with the applicable legislation.

**NOTICE**

The unit contains an automatic air purge valve. Make sure it is open. All automatic air purge valves in the system (in the unit, and in the field piping – if any) must remain open after commissioning.



8.2.6 To insulate the water piping

The piping in the complete water circuit **MUST** be insulated to prevent condensation during cooling operation and reduction of the heating and cooling capacity.

Outdoor water piping insulation

**NOTICE**

Outside piping. Make sure the outside piping is insulated as instructed to protect against hazards.

For piping in free air, it is recommended to use the insulation thickness as shown in below table as a minimum (with $\lambda=0.039$ W/mK).

Piping length (m)	Minimum insulation thickness (mm)
<20	19
20~30	32
30~40	40
40~50	50

For other cases the minimum insulation thickness can be determined using the Hydronic Piping Calculation tool.

The Hydronic Piping Calculation tool is part of the Heating Solutions Navigator which can be reached via <https://professional.standbyme.daikin.eu>.

Please contact your dealer if you have no access to Heating Solutions Navigator.

This recommendation ensures good operation of the unit, however, local regulations may differ and shall be followed.

9 Electrical installation

In this chapter

9.1	About connecting the electrical wiring	72
9.1.1	Precautions when connecting the electrical wiring	72
9.1.2	Guidelines when connecting the electrical wiring	73
9.1.3	About electrical compliance	74
9.1.4	About preferential kWh rate power supply.....	74
9.1.5	Overview of electrical connections except external actuators.....	75
9.2	Specifications of standard wiring components.....	77
9.3	Connections to the outdoor unit.....	77
9.3.1	To connect the electrical wiring to the outdoor unit.....	79
9.3.2	To connect the main power supply	80
9.3.3	External backup heater kit	83
9.3.4	To connect the user interface.....	89
9.3.5	To connect the shut-off valve	92
9.3.6	To connect the electricity meters.....	93
9.3.7	To connect the alarm output.....	94
9.3.8	To connect the space cooling/heating ON/OFF output	95
9.3.9	To connect the changeover to external heat source	96
9.3.10	To connect the power consumption digital inputs	97
9.3.11	To connect the safety thermostat (normally closed contact).....	98
9.3.12	To connect a Smart Grid	98
9.3.13	To connect the WLAN cartridge (delivered as accessory).....	102

9.1 About connecting the electrical wiring

Before connecting the electrical wiring

Make sure the water piping is connected.

Typical workflow

Connecting the electrical wiring typically consists of the following stages:

- "9.3 Connections to the outdoor unit" [▶ 77]

9.1.1 Precautions when connecting the electrical wiring



DANGER: RISK OF ELECTROCUTION



WARNING

- All wiring **MUST** be performed by an authorised electrician and **MUST** comply with the applicable national wiring regulation.
- Make electrical connections to the fixed wiring.
- All components procured on-site and all electrical construction **MUST** comply with the applicable legislation.



WARNING

ALWAYS use multicore cable for power supply cables.



INFORMATION

Also read the precautions and requirements in the "2 General safety precautions" [▶ 9].

**WARNING**

- If the power supply has a missing or wrong N-phase, equipment might break down.
- Establish proper earthing. Do NOT earth the unit to a utility pipe, surge absorber, or telephone earth. Incomplete earthing may cause electrical shocks.
- Install the required fuses or circuit breakers.
- Secure the electrical wiring with cable ties so that the cables do NOT come in contact with sharp edges or piping, particularly on the high-pressure side.
- Do NOT use taped wires, extension cords, or connections from a star system. They can cause overheating, electrical shocks or fire.
- Do NOT install a phase advancing capacitor, because this unit is equipped with an inverter. A phase advancing capacitor will reduce performance and may cause accidents.

**CAUTION**

Do NOT push or place redundant cable length into the unit.

**NOTICE**

The distance between the high voltage and low voltage cables should be at least 50 mm.

9.1.2 Guidelines when connecting the electrical wiring

**NOTICE**

We recommend using solid (single-core) wires. If stranded wires are used, slightly twist the strands to consolidate the end of the conductor for either direct use in the terminal clamp or insertion in a round crimp-style terminal.

To prepare stranded conductor wire for installation

Method 1: Twisting conductor

- 1 Strip insulation (20 mm) from the wires.
- 2 Slightly twist the end of the conductor to create a "solid-like" connection.

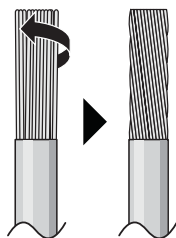

Method 2: Using round crimp-style terminal

- 1 Strip insulation from wires and slightly twist the end of each wire.
- 2 Install a round crimp-style terminal on the end of the wire. Place the round crimp-style terminal on the wire up to the covered part and fasten the terminal with the appropriate tool.

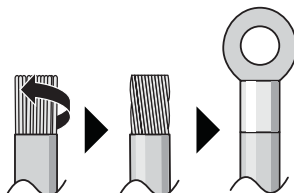

Use the following methods for installing wires:

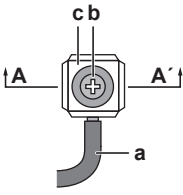
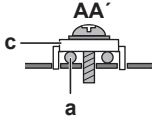
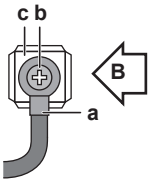
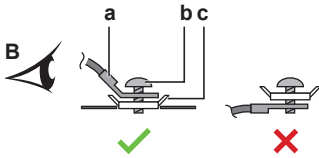
Wire type	Installation method
Single-core wire Or Stranded conductor wire twisted to "solid-like" connection	  <p>a Curled wire (single-core or twisted stranded conductor wire) b Screw c Flat washer</p>
Stranded conductor wire with round crimp-style terminal	  <p>a Terminal b Screw c Flat washer ✓ Allowed ✗ NOT allowed</p>

Tightening torques

Item	Tightening torque (N•m)
X1M	2.45 ±10%
X2M	0.88 ±10%
X3M	0.88 ±10%
X4M	2.45 ±10%
X5M	0.88 ±10%
X7M	0.88 ±10%
X9M	2.45 ±10%
X10M	0.88 ±10%

9.1.3 About electrical compliance

Equipment complying with EN/IEC 61000-3-12 (European/International Technical Standard setting the limits for harmonic currents produced by equipment connected to public low-voltage systems with input current >16 A and ≤75 A per phase.).

9.1.4 About preferential kWh rate power supply

Electricity companies throughout the world work hard to provide reliable electric service at competitive prices and are often authorised to bill clients at benefit rates. E.g. time-of-use rates, seasonal rates, Wärmepumpentarif in Germany and Austria, ...

This equipment allows for connection to such preferential kWh rate power supply delivery systems.

Consult with the electricity company acting as provider at the site where this equipment is to be installed to know whether it is appropriate to connect the equipment in one of the preferential kWh rate power supply delivery systems available, if any.

When the equipment is connected to such preferential kWh rate power supply, the electricity company is allowed to:

- interrupt power supply to the equipment for certain periods of time;
- demand that the equipment ONLY consumes a limited amount of electricity during certain periods of time.

The hydro module of the outdoor unit is designed to receive an input signal by which the unit switches into forced off mode. At that moment, the outdoor unit compressor will not operate.

The wiring to the unit is different depending on whether the power supply is interrupted or NOT.

9.1.5 Overview of electrical connections except external actuators

This topic describes the following power supply layouts:

- Normal kWh rate power supply
- Preferential kWh rate power supply WITHOUT separate normal kWh rate power supply
- Preferential kWh rate power supply WITH separate normal kWh rate power supply

Normal kWh rate power supply

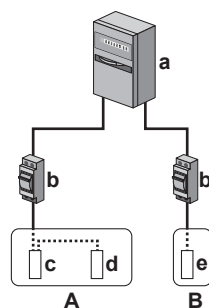

- A** Outdoor unit
- B** External backup heater kit
- a** Electrical cabinet: **Normal kWh rate power supply**
- b** Overcurrent fuse
- c** Compressor module
- d** Hydro module
- e** Backup heater

Preferential kWh rate power supply WITHOUT separate normal kWh rate power supply

During preferential kWh rate power supply activation, power supply is NOT interrupted. The compressor module of the outdoor unit is turned off by the control.

Remark: The electricity company must always allow the power consumption of the hydro module of the outdoor unit.

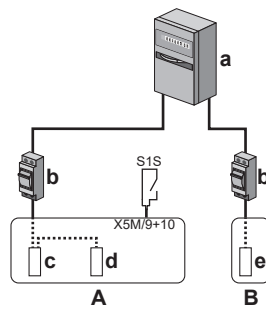

- A** Outdoor unit
- B** External backup heater kit
- a** Electrical cabinet: **Preferential kWh rate power supply**
- b** Overcurrent fuse
- c** Compressor module
- d** Hydro module
- e** Backup heater
- S1S** Preferential kWh rate power supply contact

Preferential kWh rate power supply WITH separate normal kWh rate power supply

During preferential kWh rate power supply activation, power supply is interrupted immediately or after some time by the electricity company. In this case, the hydro module of the outdoor unit must be powered by a separate normal kWh rate power supply.

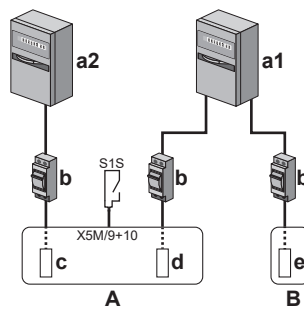

- A** Outdoor unit
- B** External backup heater kit
- a1** Electrical cabinet: **Normal kWh rate power supply**
- a2** Electrical cabinet: **Preferential kWh rate power supply**
- b** Overcurrent fuse
- c** Compressor module
- d** Hydro module
- e** Backup heater
- S1S** Preferential kWh rate power supply contact













9.2 Specifications of standard wiring components







Component		V3		
		4	6	8
Power supply cable	MCA ^(a)	19,9 A		24 A
	Voltage	220-240 V		
	Phase	1~		
	Frequency	50 Hz		
	Wire size	MUST comply with national wiring regulation. 3-core cable Wire size based on the current, but not less than 2.5 mm ²		
Recommended field fuse		20 A		25 A
Earth leakage circuit breaker / residual current device		30 mA – MUST comply with national wiring regulation		

^(a) MCA=Minimum circuit ampacity. Stated values are maximum values.

9.3 Connections to the outdoor unit

Item	Description
Power supply (main)	See "9.3.2 To connect the main power supply" [▶ 80].
User interface	See "9.3.4 To connect the user interface" [▶ 89].
Shut-off valve	See "9.3.5 To connect the shut-off valve" [▶ 92].
Electricity meters	See "9.3.6 To connect the electricity meters" [▶ 93].
Alarm output	See "9.3.7 To connect the alarm output" [▶ 94].
Space cooling/heating operation control	See "9.3.8 To connect the space cooling/heating ON/OFF output" [▶ 95].
Changeover to external heat source control	See "9.3.9 To connect the changeover to external heat source" [▶ 96].
Power consumption digital inputs	See "9.3.10 To connect the power consumption digital inputs" [▶ 97].
Safety thermostat	See "9.3.11 To connect the safety thermostat (normally closed contact)" [▶ 98].
Smart Grid	See "9.3.12 To connect a Smart Grid" [▶ 98].
Backup heater kit + Bypass valve kit	See "9.3.3 External backup heater kit" [▶ 83]

Item	Description	
Room thermostat (wired or wireless)		<p>In case of wireless room thermostat, see:</p> <ul style="list-style-type: none"> Installation manual of the wireless room thermostat Addendum book for optional equipment <p>In case of wired room thermostat, see:</p> <ul style="list-style-type: none"> Installation manual of the wired room thermostat Addendum book for optional equipment
		<p>Wires: 0.75 mm² Maximum running current: 100 mA</p>
		<p>For the main zone:</p> <ul style="list-style-type: none"> [2.9] Control [2.A] Ext thermostat type <p>For the additional zone:</p> <ul style="list-style-type: none"> [3.A] Ext thermostat type [3.9] (read-only) Control
Remote outdoor sensor		<p>See:</p> <ul style="list-style-type: none"> Installation manual of the remote outdoor sensor Addendum book for optional equipment
		<p>Wires: 2×0.75 mm²</p>
		<p>[9.B.1]=1 (External sensor = Outdoor) [9.B.2] Ext. amb. sensor offset [9.B.3] Averaging time</p>
Remote indoor sensor		<p>See:</p> <ul style="list-style-type: none"> Installation manual of the remote indoor sensor Addendum book for optional equipment
		<p>Wires: 2×0.75 mm²</p>
		<p>[9.B.1]=2 (External sensor = Room) [1.7] Room sensor offset</p>
Human Comfort Interface		<p>See:</p> <ul style="list-style-type: none"> Installation and operation manual of the Human Comfort Interface Addendum book for optional equipment
		<p>Wires: 2×(0.75~1.25 mm²) Maximum length: 500 m</p>
		<p>[2.9] Control [1.6] Room sensor offset</p>

Item	Description	
WLAN cartridge		See: <ul style="list-style-type: none"> Installation manual of the WLAN cartridge Installer reference guide
		—
		[D] Wireless gateway
Flow switch		See installation manual of the flow switch
		Wires: 2×0.5 mm ²
		—

Location extra components

The following illustration shows the location of the extra components that you need to install on the outdoor unit when using certain option kits.

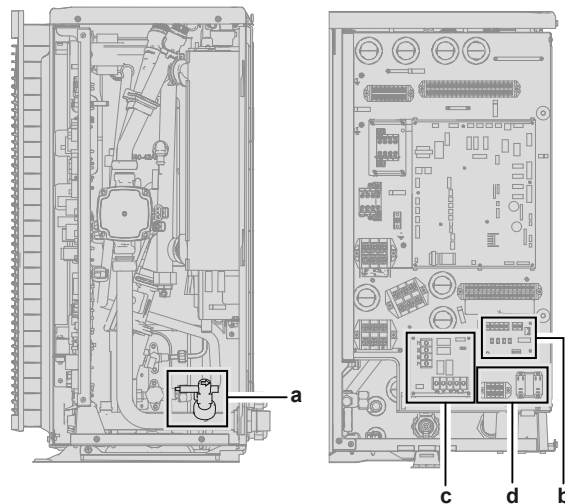

- a** Flow switch (EKFLSW2)
- b** Demand PCB (A8P: EKRP1AHTA)
- c** Digital I/O PCB (A4P: EKRP1HBAA)
- d** Smart grid relay kit (EKRELSG)

9.3.1 To connect the electrical wiring to the outdoor unit

- 1 Open the service cover. See "7.3.2 To open the outdoor unit" [▶ 56]. If necessary, rotate the switch box. See "7.3.3 To rotate the switch box" [▶ 57].
- 2 Strip insulation (20 mm) from the wires.

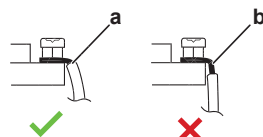

- a** Strip wire end to this point
 - b** An excessive strip length may cause electrical shock or leakage
- 3 Insert the cables at the back of the unit, and route them through the unit to the appropriate terminal blocks.

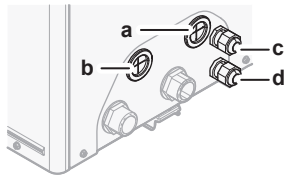

- a High voltage options
- b Low voltage options
- c Power supply for backup heater (in case of unit with integrated backup heater)
Wiring for backup heater kit (in case of external backup heater kit)
- d Unit power supply

4 Connect the wires to the appropriate terminals, and fix the cables with cable ties.

9.3.2 To connect the main power supply

This topic describes 2 possible ways to connect the main power supply:

- In case of normal kWh rate power supply
- In case of preferential kWh rate power supply

In case of normal kWh rate power supply

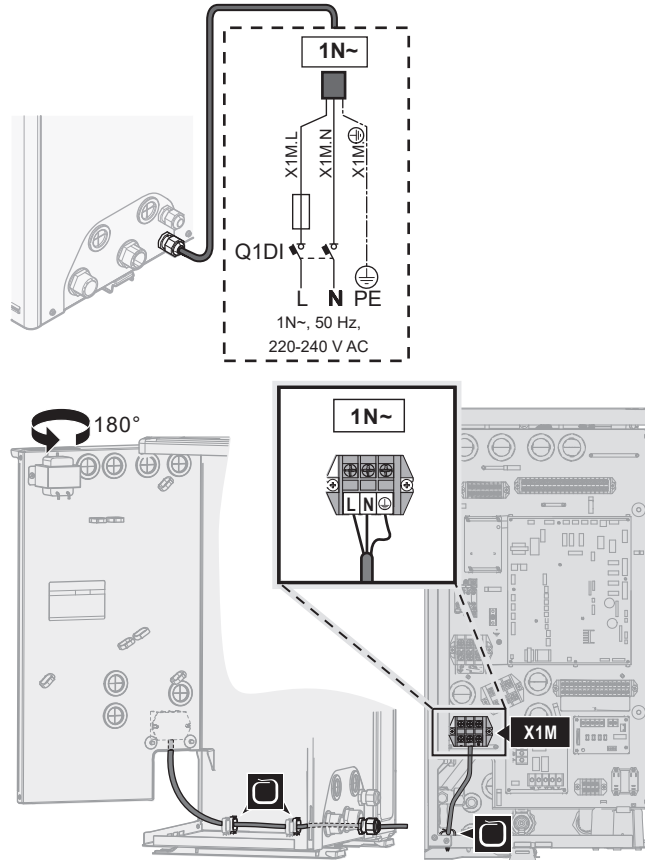

	Normal kWh rate power supply	Wires: 1N+GND Maximum running current: Refer to name plate on unit.
	—	—

1 Connect as follows:



2 Fix the cables with cable ties to the cable tie mountings.

In case of preferential kWh rate power supply

	Preferential kWh rate power supply	Wires: 1N+GND Maximum running current: Refer to name plate on unit.
	Separate normal kWh rate power supply	Wires: 1N Maximum running current: 6.3 A
	Preferential kWh rate power supply contact	Wires: 2x(0.75~1.25 mm ²) Maximum length: 50 m. Preferential kWh rate power supply contact: 16 V DC detection (voltage supplied by PCB). The voltage-free contact shall ensure the minimum applicable load of 15 V DC, 10 mA.
	[9.8] Benefit kWh power supply	

- 1 Connect the preferential kWh rate power supply.

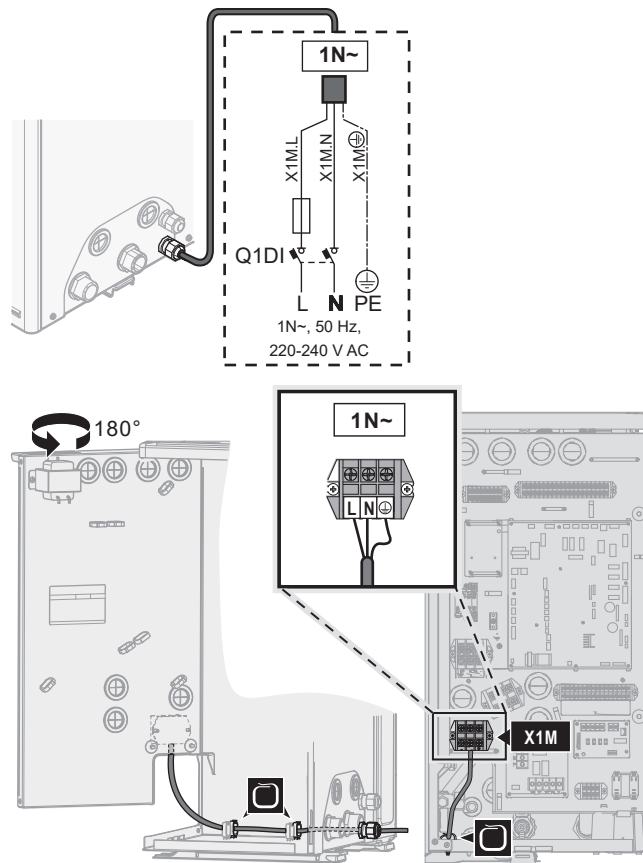

- 2 If necessary, connect the separate normal kWh rate power supply.

**INFORMATION**

Some types of preferential kWh rate power supply require a separate normal kWh rate power supply to the outdoor unit. This is required in the following cases:

- if the preferential kWh rate power supply is interrupted when active, OR
- if no power consumption of the hydro module of the outdoor unit is allowed at the preferential kWh rate power supply when active.

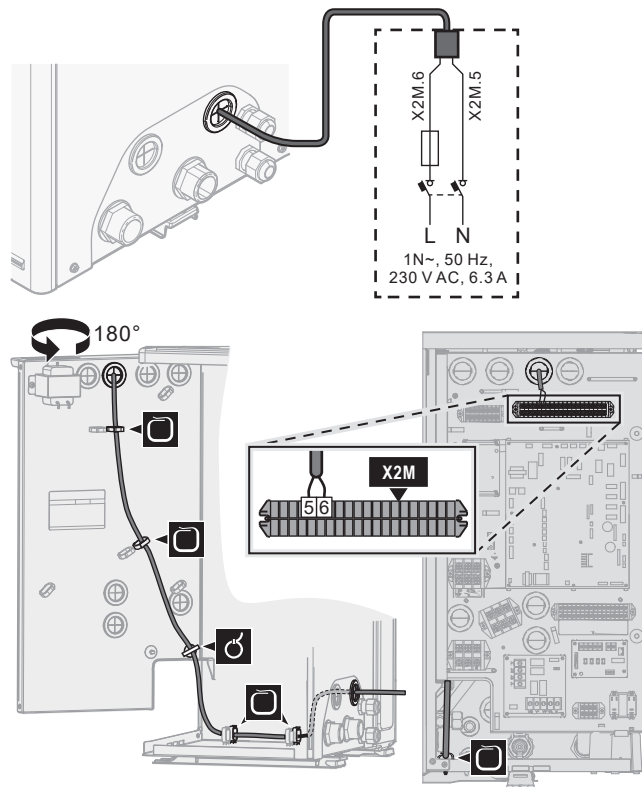

3 Connect the preferential power supply contact.

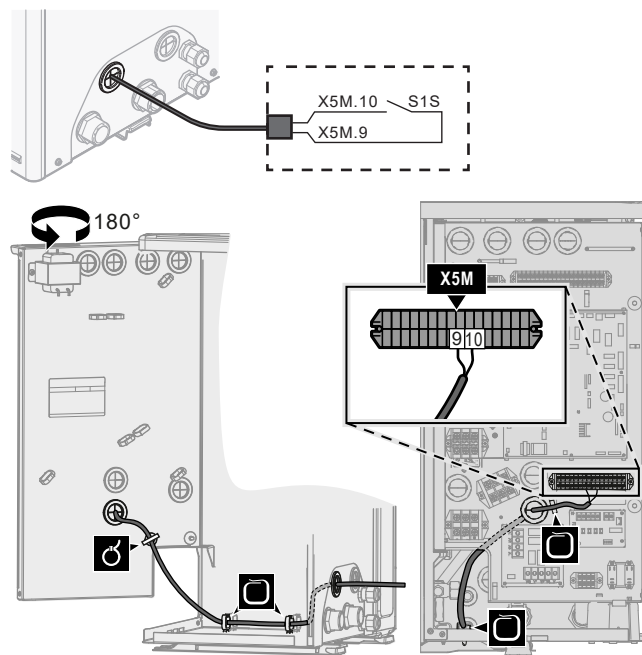

4 In case of a separate normal kWh rate power supply, disconnect X11Y from X11YA, and connect X11Y to X11YB.

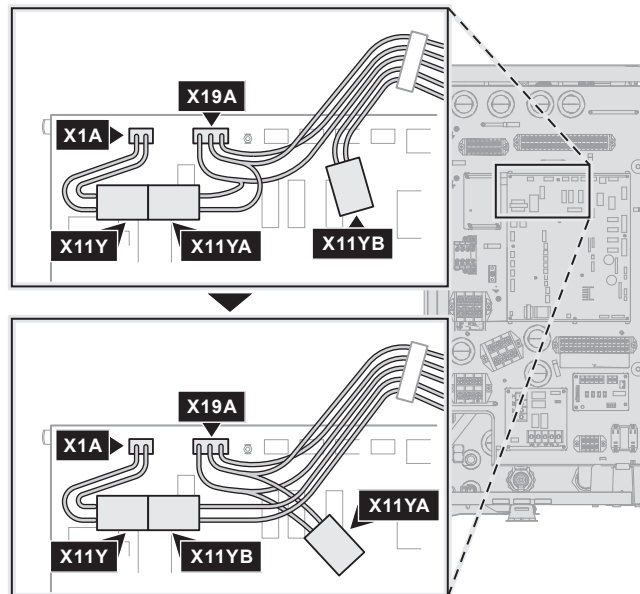

- 5 Fix the cables with cable ties to the cable tie mountings.

9.3.3 External backup heater kit

For reversible models, you can install the external backup heater kit (EKLBUHCB6W1).

If you do so, then under certain conditions you also need to install a bypass valve kit (EKMBHBP1).



See:

- ["To connect the backup heater kit" \[▶ 83\]](#)
- ["Bypass valve kit necessity" \[▶ 87\]](#)
- ["To connect the bypass valve kit" \[▶ 88\]](#)

To connect the backup heater kit

The installation of the external backup heater kit is described in the installation manual of the kit. However, certain parts of it are superseded by the information described here. It concerns the following:

- To connect the backup heater kit power supply
- To connect the backup heater kit to the outdoor unit

	Wires: See installation manual of the backup heater kit
	[9.3] Backup heater

To connect the backup heater kit power supply



CAUTION

To guarantee the unit is completely earthed, ALWAYS connect the backup heater power supply and the earth cable.



WARNING

The backup heater MUST have a dedicated power supply and MUST be protected by the safety devices required by the applicable legislation.

Depending on the configuration (wiring on X14M, and settings in [9.3] Backup heater), the backup heater capacity can vary. Make sure that the power supply is in accordance with the backup heater capacity, as listed in the table below.

Backup heater type	Backup heater capacity	Power supply	Maximum running current	$Z_{max}(\Omega)$
*6W	3 kW	1N~ 230 V	13 A	—
	6 kW	1N~ 230 V	26 A ^{(a)(b)}	—
	6 kW	3N~ 400 V	8.6 A	—
	9 kW	3N~ 400 V	13 A	—

^(a) This equipment complies with EN/IEC 61000-3-11 (European/International Technical Standard setting the limits for voltage changes, voltage fluctuations and flicker in public low-voltage supply systems for equipment with rated current ≤ 75 A) provided that the system impedance Z_{sys} is less than or equal to Z_{max} at the interface point between the user's supply and the public system. It is the responsibility of the installer or user of the equipment to ensure, by consultation with the distribution network operator if necessary, that the equipment is connected only to a supply with a system impedance Z_{sys} less than or equal to Z_{max} .

^(b) Electrical equipment complying with EN/IEC 61000-3-12 (European/International Technical Standard setting the limits for harmonic currents produced by equipment connected to public low-voltage systems with input current >16 A and ≤ 75 A per phase).

- 1 Connect the backup heater power supply. A 4-pole fuse is used for F1B.
- 2 If required, modify the connection on terminal X14M.

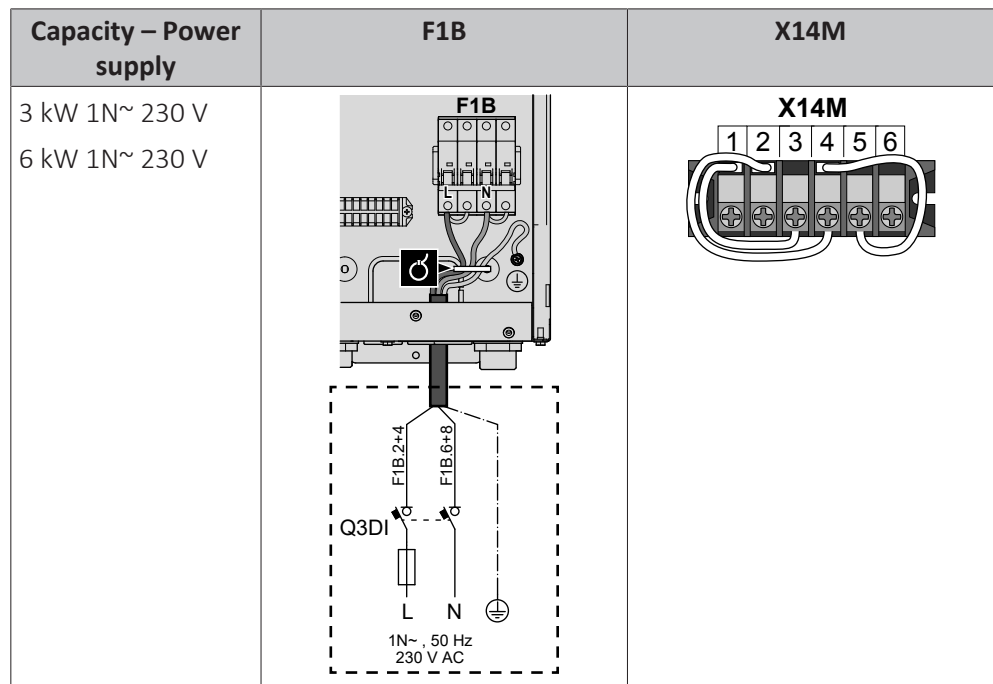

Capacity – Power supply	F1B	X14M
6 kW 3N~ 400 V 9 kW 3N~ 400 V		

3 Fix the cable with cable ties to the cable tie mountings.

During connection of the backup heater, miswiring is possible. To detect possible miswiring, it is highly recommended to measure the resistance value of the heater elements. Depending on the capacity and power supply, following resistance values (see table below) should be measured. ALWAYS measure the resistance on the contactor clamps K1M, K2M, and K5M.

		3 kW 1N~ 230 V	6 kW 1N~ 230 V	6 kW 3N~ 400 V	9 kW 3N~ 400 V
K1M/1	K5M/13	52.9Ω	52.9Ω	∞	∞
	K1M/3	∞	105.8Ω	105.8Ω	105.8Ω
	K1M/5	∞	158.7Ω	105.8Ω	105.8Ω
K1M/3	K1M/5	26.5Ω	52.9Ω	105.8Ω	105.8Ω
K2M/1	K5M/13	∞	26.5Ω	∞	∞
	K2M/3	∞	∞	52.9Ω	52.9Ω
	K2M/5	∞	∞	52.9Ω	52.9Ω
K2M/3	K2M/5	52.9Ω	52.9Ω	52.9Ω	52.9Ω
K1M/5	K2M/1	∞	132.3Ω	∞	∞

Example measure resistance between K1M/1 and K5M/13:

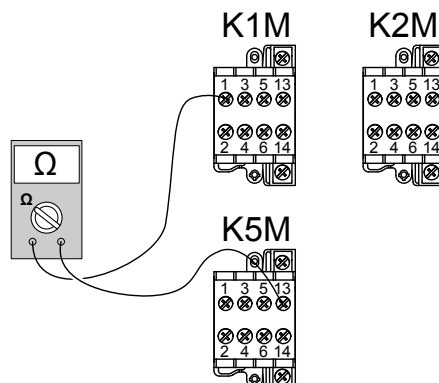

To connect the backup heater kit to the outdoor unit

The wiring between the backup heater kit and the outdoor unit is as follows:

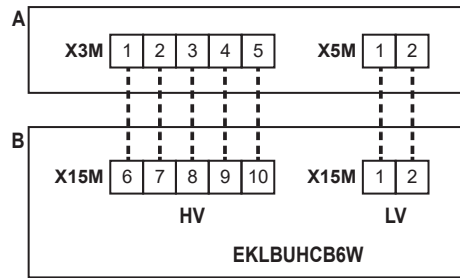

- A** Outdoor unit
- B** Backup heater kit
- HV** High voltage connections (backup heater thermal protector + backup heater connection)
- LV** Low voltage connection (backup heater thermistor)

NOTICE
 The distance between the high voltage and low voltage cables should be at least 50 mm.

- 1** On the backup heater kit, connect the LV and HV cables to the appropriate terminals as shown in the illustration below.

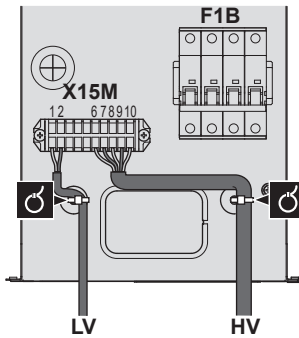

- 2** On the outdoor unit, connect the HV cable to the appropriate terminals as shown in the illustration below.

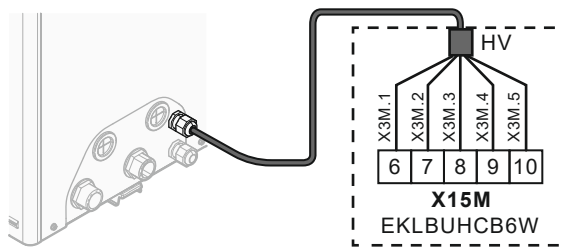

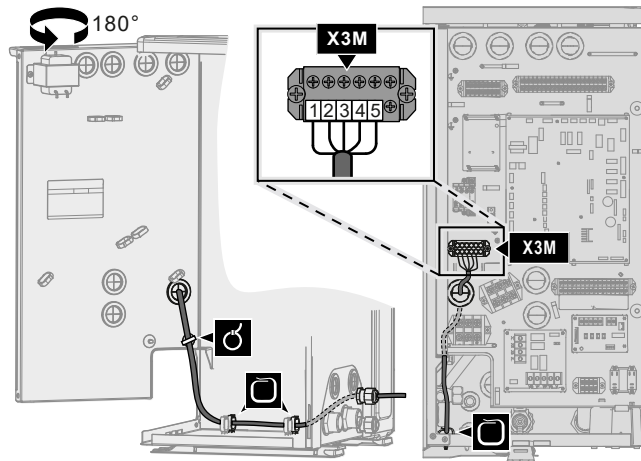

- 3 On the outdoor unit, connect the LV cable to the appropriate terminals as shown in the illustration below.

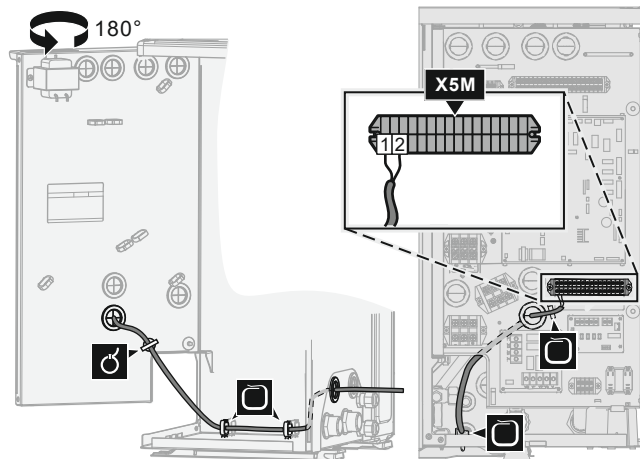
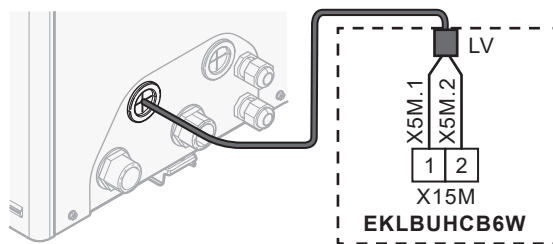

- 4 Fix the cables with cable ties to the cable tie mountings.

Bypass valve kit necessity

For reversible systems (heating+cooling) in which an external backup heater kit is installed, the installation of valve kit EKMBHBP1 is required if condensation is expected inside the backup heater.

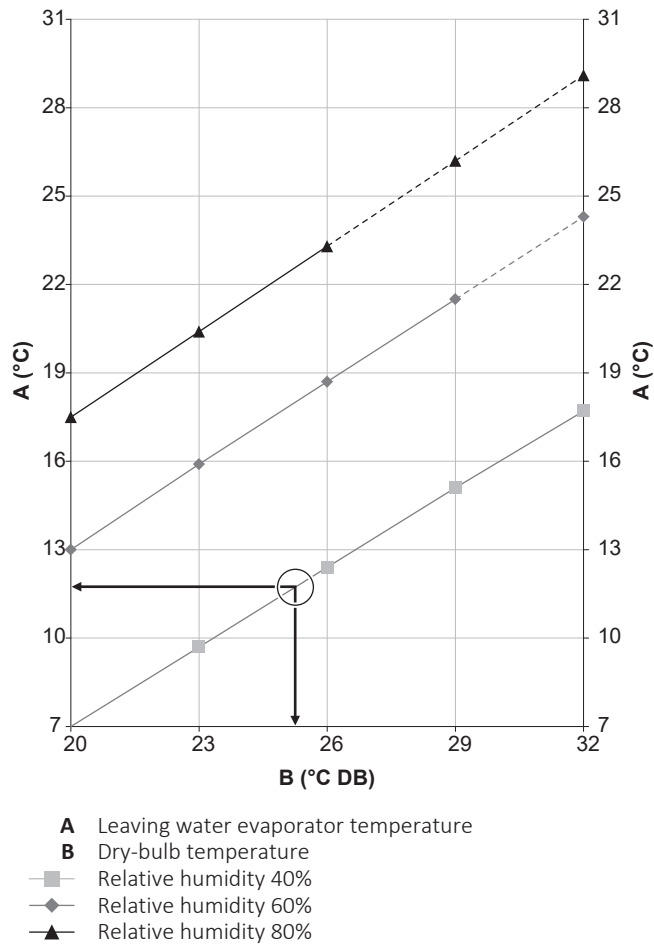



Example: Given are an ambient temperature of 25°C and a relative humidity of 40%. If the leaving water evaporator temperature is <12°C, condensation will occur.

Note: See the psychrometric chart for more information.

To connect the bypass valve kit

The information in this topic supersedes that of the instruction sheet delivered with the bypass valve kit.

	Wires: 3x0.75 mm ²
	—

The components of the bypass valve kit are as follows. You only need **B** and **D**.

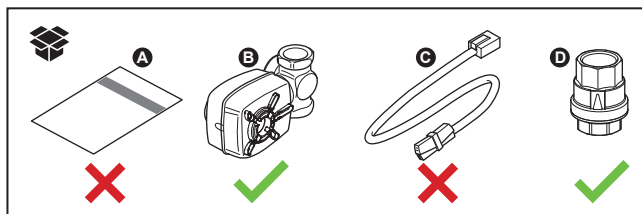

1 Integrate components **B** and **D** as follows in the system:

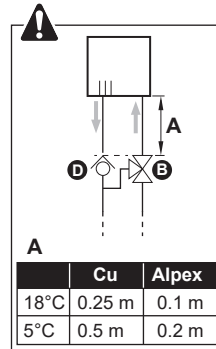
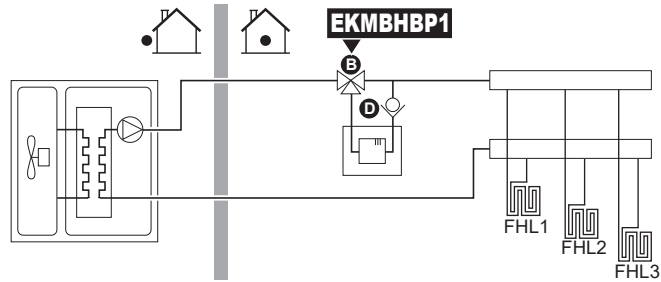

- 2 On the outdoor unit, connect **B** to the appropriate terminals as shown in the illustration below.

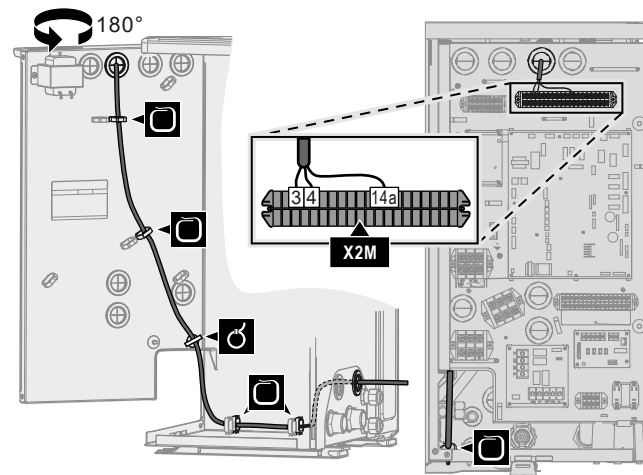
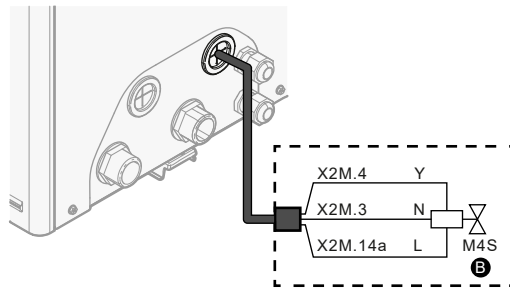

- 3 Fix the cable with cable ties to the cable tie mountings.

9.3.4 To connect the user interface

This topic describes the following:

- Connecting the user interface cable to the outdoor unit.
- Installing the user interface, and connecting the user interface cable to it.
- (if necessary) Opening the user interface after it is installed.

Connecting the user interface cable to the outdoor unit

	Wires: 4x(0.75~1.25 mm ²) Maximum length: 200 m
	[2.9] Control [1.6] Room sensor offset

- 1 Connect the user interface cable to the outdoor unit. Fix the cable with cable ties to the cable tie mountings.

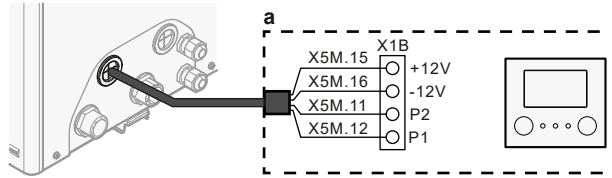

a User interface: Required for operation. Delivered with the unit as accessory.

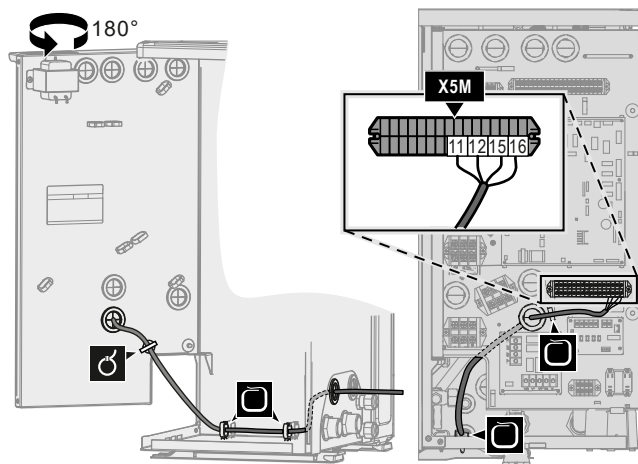

Installing the user interface, and connecting the user interface cable to it

You need the following user interface accessories (delivered on top of the unit):

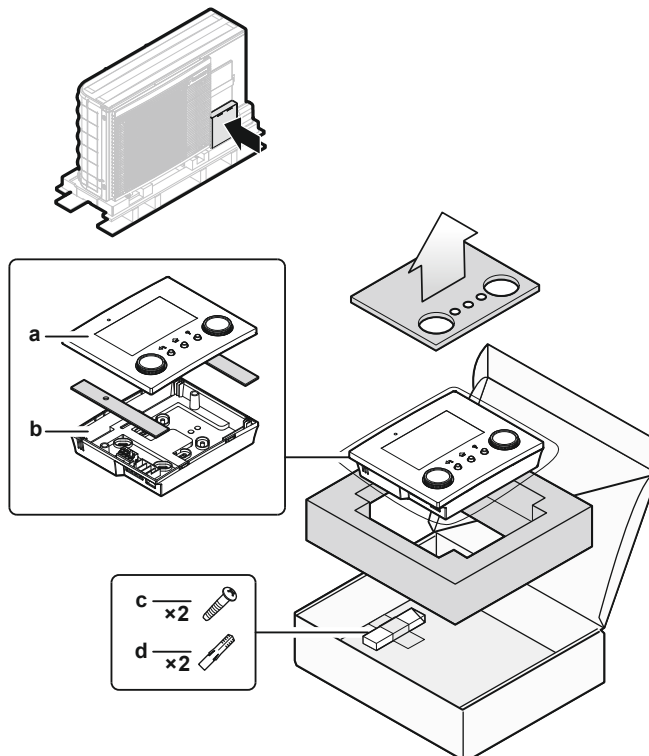

- a Front plate
- b Rear plate
- c Screws
- d Wall plugs

1 Mount the rear plate to the wall.

- Use the 2 screws and wall plugs.
- Use any of the 6 holes. The holes are compatible with standard electrical box extenders of 60 mm.

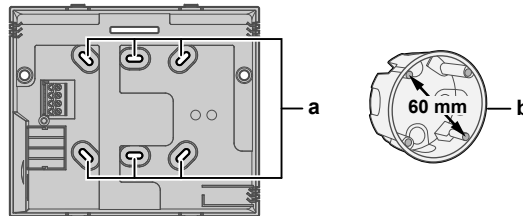

- a Holes
- b Electrical box extender (field supply)

2 Connect the user interface cable to the user interface.

- Choose one of the 4 possible wiring intakes (a, b, c or d).
- If you choose the left or right side, make a hole for the cable in the part of the casing where the casing is thinner.

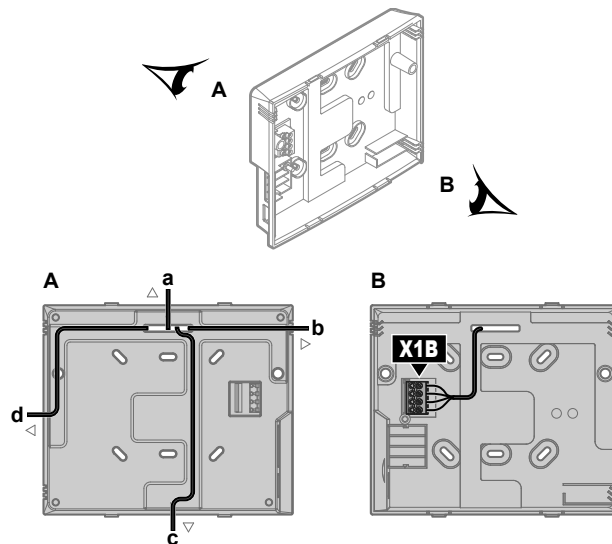

- a Top side
- b Left side
- c Bottom side
- d Right side

3 Mount the front plate.

- Align the positioning pins and push the front plate onto the rear plate until it moves into place with a click.
- The connector pins are automatically inserted correctly.

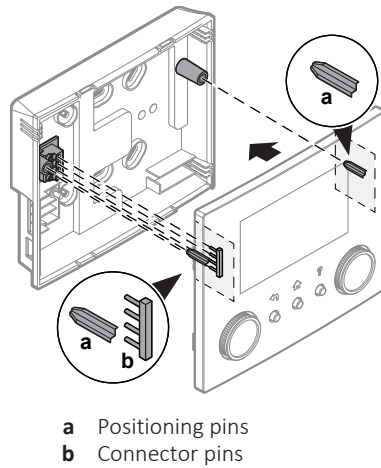

a Positioning pins
b Connector pins

Opening the user interface after it is installed

If you need to open the user interface after it is installed, proceed as follows:

- 1 Remove the WLAN cartridge and USB memory stick (if any).

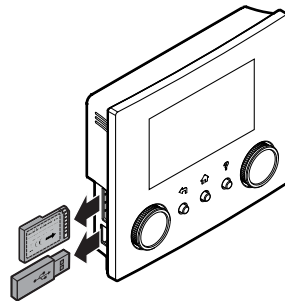

- 2 Push the rear plate on each of the 4 spots where the snap-fits are located.

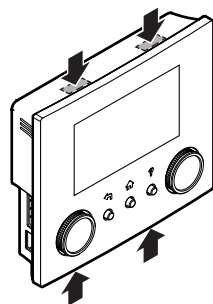

9.3.5 To connect the shut-off valve



INFORMATION

Shut-off valve usage example. In case of one LWT zone, and a combination of underfloor heating and fan coil units, install a shut-off valve before the underfloor heating to prevent condensation on the floor during cooling operation.



Wires: 2x0.75 mm²
Maximum running current: 100 mA
230 V AC supplied by PCB



—

- 1 Open the service cover. See "[7.3.2 To open the outdoor unit](#)" [▶ 56].
- 2 Connect the valve control cable to the appropriate terminals as shown in the illustration below.



NOTICE

Only connect NO (normally open) valves.

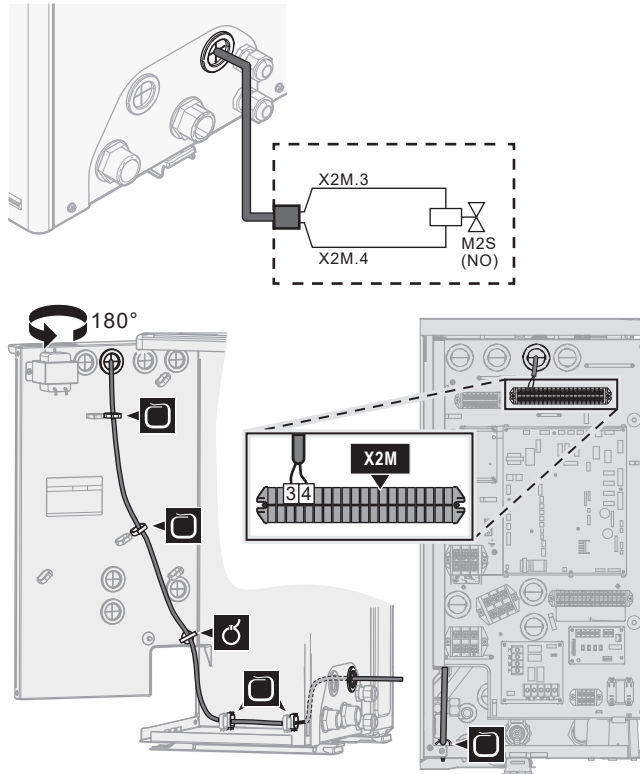

3 Fix the cable with cable ties to the cable tie mountings.

9.3.6 To connect the electricity meters

	Wires: 2 (per meter)×0.75 mm ² Electricity meters: 12 V DC pulse detection (voltage supplied by PCB)
	[9.A] Energy metering



INFORMATION

In case of an electricity meter with transistor output, check the polarity. The positive polarity **MUST** be connected to X5M/6 and X5M/4; the negative polarity to X5M/5 and X5M/3.

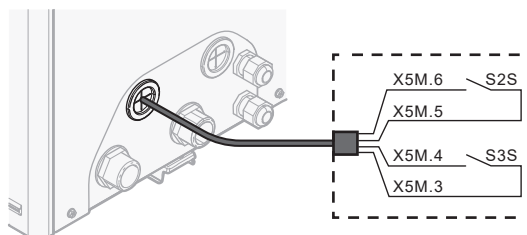

- 1 Open the service cover. See "[7.3.2 To open the outdoor unit](#)" [▶ 56].
- 2 Connect the electricity meters cable to the appropriate terminals as shown in the illustration below.

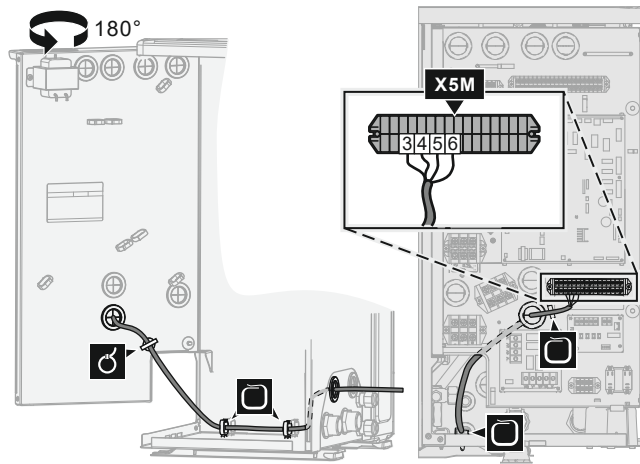



3 Fix the cable with cable ties to the cable tie mountings.

9.3.7 To connect the alarm output

	Wires: (2+1)×0.75 mm ² Maximum load: 0.3 A, 250 V AC
	[9.D] Alarm output

- 1 Open the service cover. See ["7.3.2 To open the outdoor unit"](#) [▶ 56].
- 2 Connect the alarm output cable to the appropriate terminals as shown in the illustration below.

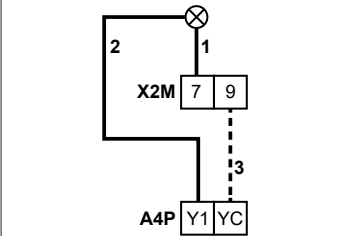
	1+2	Wires connected to the alarm output
	3	Wire between X2M and A4P
	A4P	Installation of EGRP1HBAA is required.

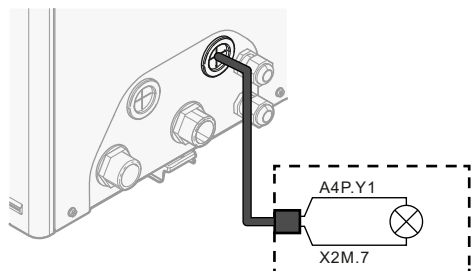

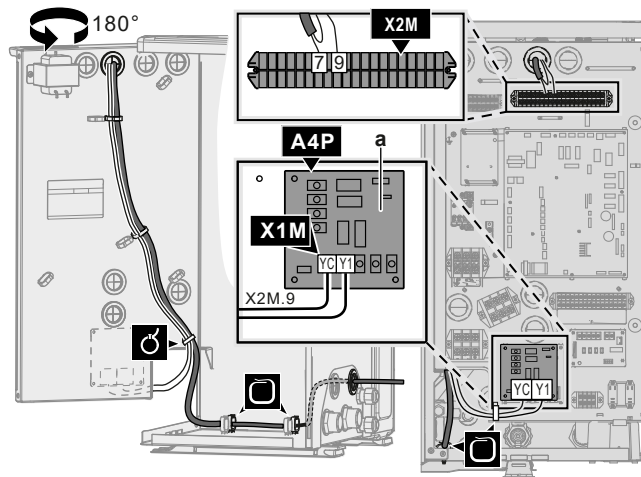

a Installation of EKR1HBAA is required.



WARNING

Stripped wire. Make sure that stripped wire cannot make contact with possible water on the bottom plate.

- 3 Fix the cable with cable ties to the cable tie mountings.

9.3.8 To connect the space cooling/heating ON/OFF output



INFORMATION

Heating is only applicable in case of reversible models.



Wires: (2+1)×0.75 mm²
Maximum load: 0.3 A, 250 V AC



—

- 1 Open the service cover. See "7.3.2 To open the outdoor unit" [▶ 56].
- 2 Connect the space cooling/heating ON/OFF output cable to the appropriate terminals as shown in the illustration below.

	1+2	Wires connected to the space cooling/heating ON/OFF output
	3	Wire between X2M and A4P
	A4P	Installation of EKR1HBAA is required.

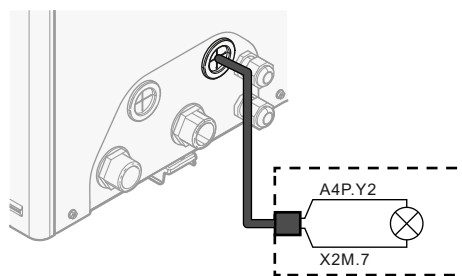

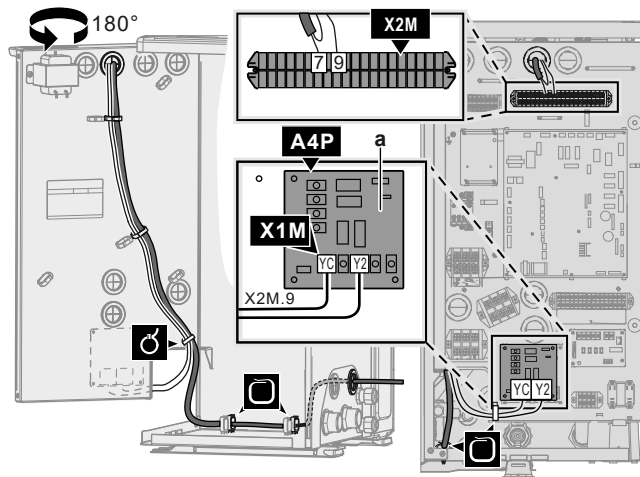

a Installation of EKR1HBAA is required.



WARNING

Stripped wire. Make sure that stripped wire cannot make contact with possible water on the bottom plate.

- 3 Fix the cable with cable ties to the cable tie mountings.

9.3.9 To connect the changeover to external heat source



INFORMATION

Bivalent is only possible in case of 1 leaving water temperature zone with:

- room thermostat control, OR
- external room thermostat control.



Wires: 2x0.75 mm²
 Maximum load: 0.3 A, 250 V AC
 Minimum load: 20 mA, 5 V DC



[9.C] Bivalent

- 1 Open the service cover. See "[7.3.2 To open the outdoor unit](#)" [▶ 56].
- 2 Connect the changeover to external heat source cable to the appropriate terminals as shown in the illustration below.

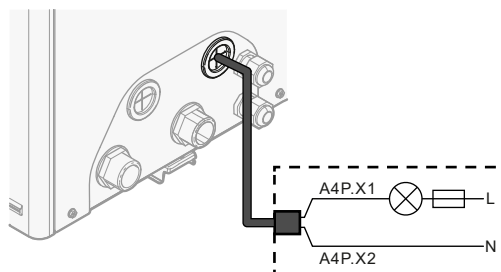

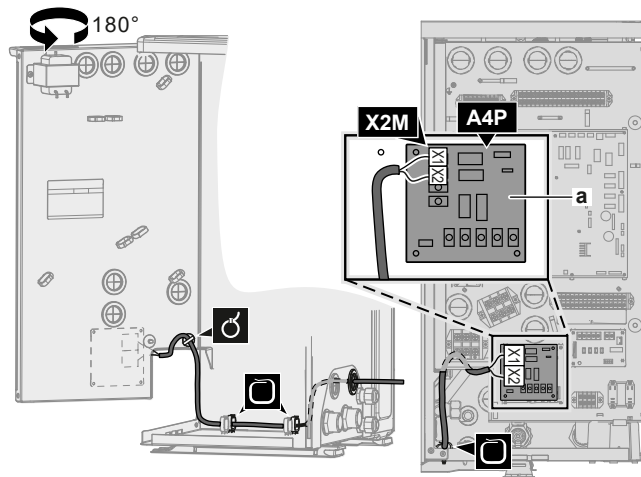

a Installation of EKR1HBAA is required.

- 3 Fix the cable with cable ties to the cable tie mountings.

9.3.10 To connect the power consumption digital inputs

	Wires: 2 (per input signal)×0.75 mm ² Power limitation digital inputs: 12 V DC / 12 mA detection (voltage supplied by PCB)
	[9.9] Power consumption control.

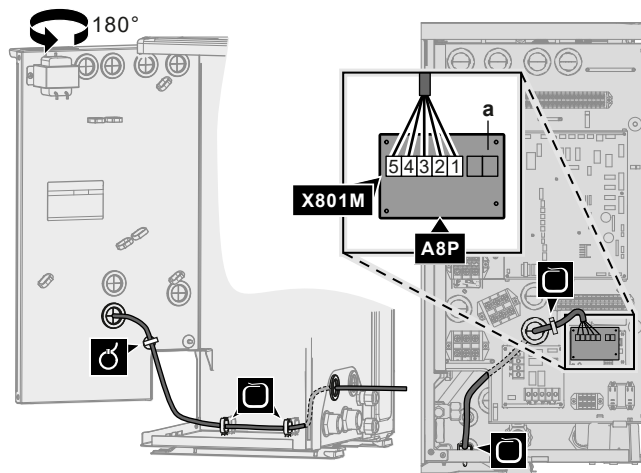
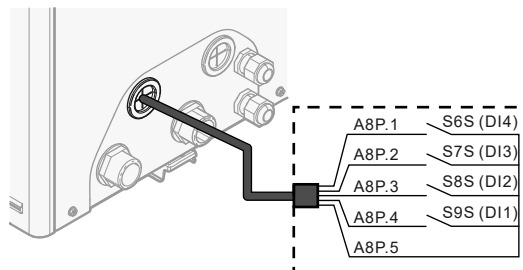

- 1 Open the service cover. See "7.3.2 To open the outdoor unit" [▶ 56].
- 2 Connect the power consumption digital inputs cable to the appropriate terminals as shown in the illustration below.



a Installation of EKR1AHTA is required.

- 3 Fix the cable with cable ties to the cable tie mountings.

9.3.11 To connect the safety thermostat (normally closed contact)

	<p>Wires: 2x0.75 mm²</p> <p>Maximum length: 50 m</p> <p>Safety thermostat contact: 16 V DC detection (voltage supplied by PCB). The voltage-free contact shall ensure the minimum applicable load of 15 V DC, 10 mA.</p>
	—

- 1 Open the service cover. See "7.3.2 To open the outdoor unit" [▶ 56].
- 2 Connect the safety thermostat (normally closed) cable to the appropriate terminals as shown in the illustration below.

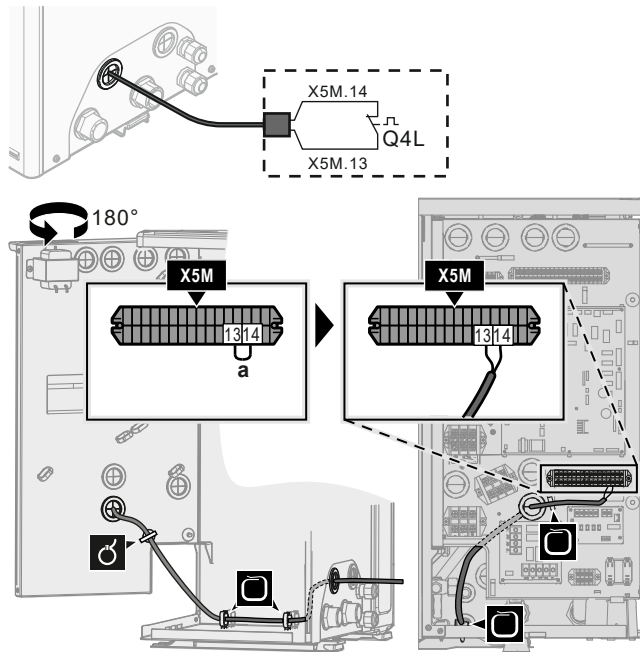

a Remove jumper

- 3 Fix the cable with cable ties to the cable tie mountings.



NOTICE

Make sure to select and install the safety thermostat according to the applicable legislation.

In any case, to prevent unnecessary tripping of the safety thermostat, we recommend the following:

- The safety thermostat is automatically resettable.
- The safety thermostat has a maximum temperature variation rate of 2°C/min.



NOTICE

Error. If you remove the jumper (open circuit) but do NOT connect the safety thermostat, stop error 8H-03 will occur.

9.3.12 To connect a Smart Grid

This topic describes 2 possible ways to connect the outdoor unit to a Smart Grid:

- In case of low voltage Smart Grid contacts

- In case of high voltage Smart Grid contacts. This requires the installation of the Smart Grid relay kit (EKRELSG).



The 2 incoming Smart Grid contacts can activate the following Smart Grid modes:

Smart Grid contact		Smart Grid operation mode
①	②	
0	0	Free running
0	1	Forced off
1	0	Recommended on
1	1	Forced on

The use of a Smart Grid pulse meter is not mandatory:

If Smart Grid pulse meter is...	Then [9.8.8] Limit setting kW is...
Used ([9.A.2] Electricity meter 2 ≠ None)	Not applicable
Not used ([9.A.2] Electricity meter 2 = None)	Applicable

In case of low voltage Smart Grid contacts

	Wires (Smart Grid pulse meter): 0.5 mm ² Wires (low voltage Smart Grid contacts): 0.5 mm ²
	[9.8.4]=3 (Benefit kWh power supply = Smart grid) [9.8.5] Smart grid operation mode [9.8.6] Allow electrical heaters [9.8.7] Enable room buffering [9.8.8] Limit setting kW

The wiring of the Smart Grid in case of low voltage contacts is as follows:

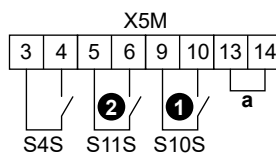

- a Jumper (factory-mounted). If you also connect a safety thermostat (Q4L), replace the jumper with the safety thermostat wires.

- S4S Smart Grid pulse meter (optional)
- ①/S10S Low voltage Smart Grid contact 1
- ②/S11S Low voltage Smart Grid contact 2

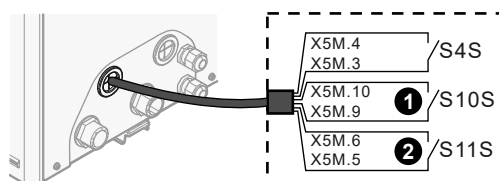

1 Connect the wiring as follows:

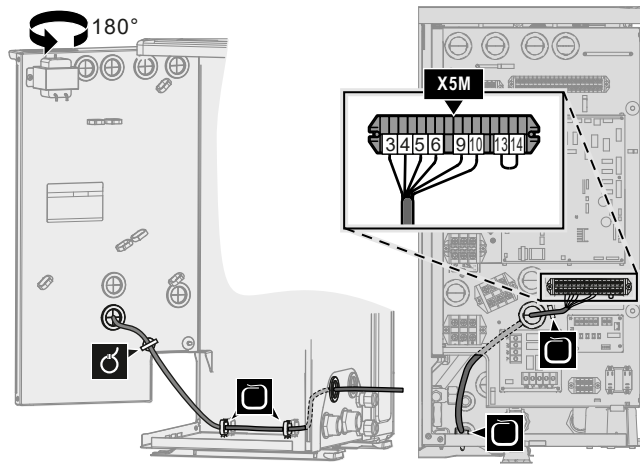



2 Fix the cables with cable ties to the cable tie mountings.

In case of high voltage Smart Grid contacts

	Wires (Smart Grid pulse meter): 0.5 mm ² Wires (high voltage Smart Grid contacts): 1 mm ²
	[9.8.4]=3 (Benefit kWh power supply = Smart grid) [9.8.5] Smart grid operation mode [9.8.6] Allow electrical heaters [9.8.7] Enable room buffering [9.8.8] Limit setting kW

The wiring of the Smart Grid in case of high voltage contacts is as follows:

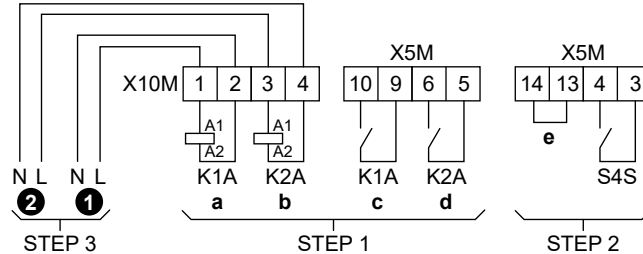

- STEP 1** Smart Grid relay kit installation
- STEP 2** Low voltage connections
- STEP 3** High voltage connections
 - ① High voltage Smart Grid contact 1
 - ② High voltage Smart Grid contact 2
- K1A** Relay for Smart Grid contact 1
- K2A** Relay for Smart Grid contact 2
- a, b** Coil sides of relays
- c, d** Contact sides of relays
- e** Jumper (factory-mounted). If you also connect a safety thermostat (Q4L), replace the jumper with the safety thermostat wires.
- S4S** Smart Grid pulse meter (optional)

1 Install the components of the Smart Grid relay kit as follows:

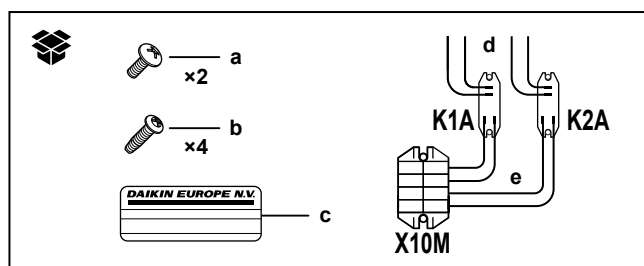

- K1A** Relay for Smart Grid contact 1
- K2A** Relay for Smart Grid contact 2
- X10M** Terminal block
 - a** Screws for X10M
 - b** Screws for K1A and K2A
 - c** Sticker to put on the high voltage wires
 - d** Wires between the relays and X5M (AWG22 ORG)
 - e** Wires between the relays and X10M (AWG18 RED)

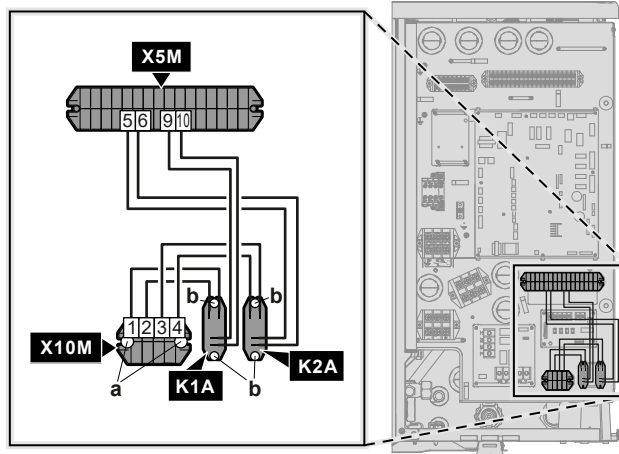

2 Connect the low voltage wiring as follows:

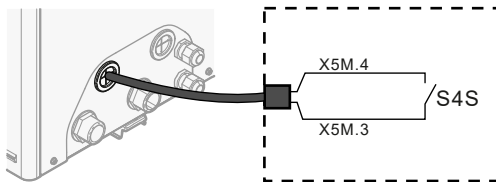

S4S Smart Grid pulse meter (optional)

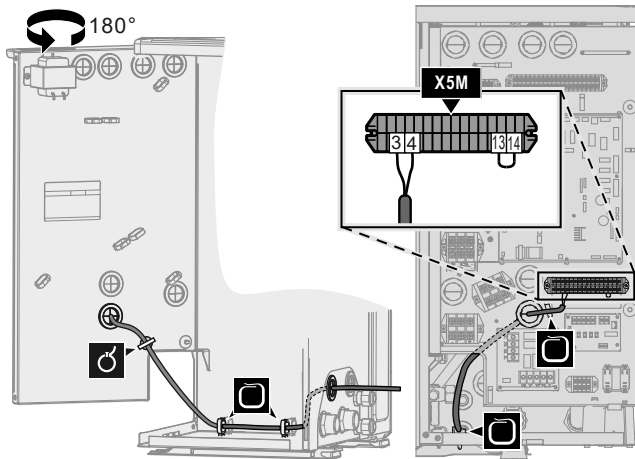

3 Connect the high voltage wiring as follows:

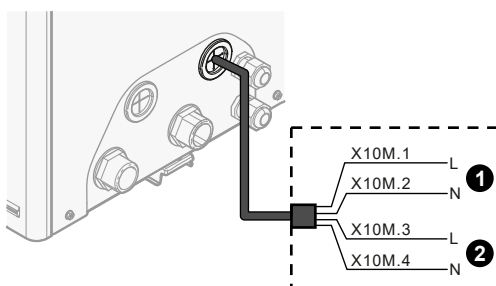

- 1** High voltage Smart Grid contact 1
- 2** High voltage Smart Grid contact 2

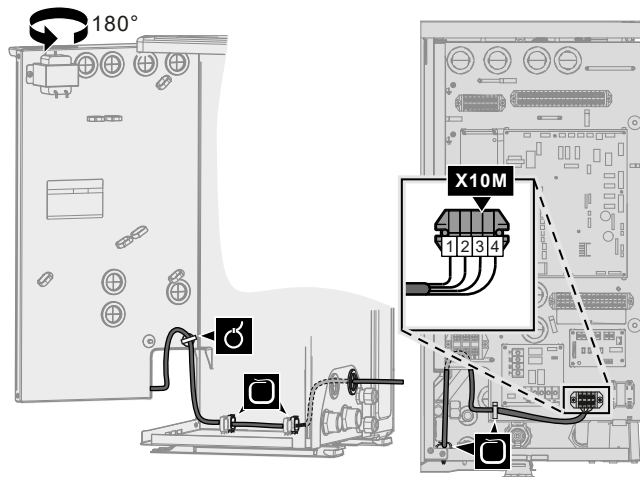

- 4 Fix the cables with cable ties to the cable tie mountings. If necessary, bundle excessive cable length with a cable tie.

9.3.13 To connect the WLAN cartridge (delivered as accessory)

	[D] Wireless gateway
---	----------------------

- 1 Insert the WLAN cartridge into the cartridge slot on the user interface of the indoor unit.

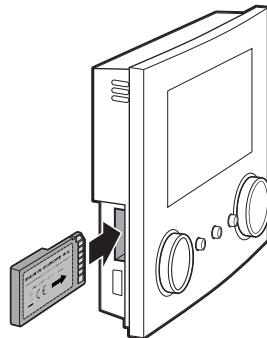

10 Configuration



INFORMATION

Heating is only applicable in case of reversible models.

In this chapter

10.1	Overview: Configuration.....	103
10.1.1	To access the most used commands	104
10.1.2	To connect the PC cable to the switch box	106
10.2	Configuration wizard	107
10.3	Possible screens	108
10.3.1	Possible screens: Overview	108
10.3.2	Home screen	109
10.3.3	Main menu screen	111
10.3.4	Menu screen.....	112
10.3.5	Setpoint screen	113
10.3.6	Detailed screen with values	114
10.4	Preset values and schedules.....	114
10.4.1	Using preset values	114
10.4.2	Using and programming schedules	115
10.4.3	Schedule screen: Example	117
10.4.4	Setting the energy prices	121
10.5	Weather-dependent curve.....	123
10.5.1	What is a weather-dependent curve?.....	123
10.5.2	2-points curve.....	124
10.5.3	Slope-offset curve	125
10.5.4	Using weather-dependent curves	126
10.6	Settings menu.....	128
10.6.1	Malfunctioning	128
10.6.2	Room	128
10.6.3	Main zone.....	133
10.6.4	Additional zone	142
10.6.5	Space heating/cooling.....	146
10.6.6	User settings.....	156
10.6.7	Information.....	160
10.6.8	Installer settings	161
10.6.9	Commissioning	180
10.6.10	User profile.....	180
10.6.11	Operation	181
10.6.12	WLAN.....	181
10.7	Menu structure: Overview user settings.....	184
10.8	Menu structure: Overview installer settings.....	185

10.1 Overview: Configuration

This chapter describes what you have to do and know to configure the system after it is installed.

Why

If you do NOT configure the system correctly, it might NOT work as expected. The configuration influences the following:

- The calculations of the software
- What you can see on and do with the user interface

How

You can configure the system via the user interface.

- **First time – Configuration wizard.** When you turn ON the user interface for the first time (via the unit), the configuration wizard starts to help you configure the system.
- **Restart the configuration wizard.** If the system is already configured, you can restart the configuration wizard. To restart the configuration wizard, go to **Installer settings > Configuration wizard**. To access **Installer settings**, see "10.1.1 To access the most used commands" [▶ 104].
- **Afterwards.** If necessary, you can make changes to the configuration in the menu structure or the overview settings.

i

INFORMATION

When the configuration wizard is finished, the user interface will show an overview screen and request to confirm. When confirmed, the system will restart and the home screen will be displayed.

Accessing settings – Legend for tables

You can access the installer settings using two different methods. However, NOT all settings are accessible via both methods. If so, the corresponding table columns in this chapter are set to N/A (not applicable).

Method	Column in tables
Accessing settings via the breadcrumb in the home menu screen or the menu structure . To enable breadcrumbs, press the ? button in the home screen.	# For example: [2.9]
Accessing settings via the code in the overview field settings .	Code For example: [C-07]





See also:

- "To access the installer settings" [▶ 105]
- "10.8 Menu structure: Overview installer settings" [▶ 185]

10.1.1 To access the most used commands

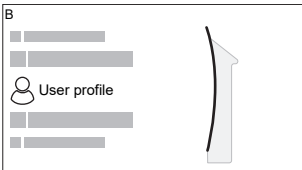
To change the user permission level

You can change the user permission level as follows:

1	Go to [B]: User profile. 	
2	Enter the applicable pin code for the user permission level.	—
	▪ Browse through the list of digits and change the selected digit.	
	▪ Move the cursor from left to right.	
	▪ Confirm the pin code and proceed.	

Installer pin code

The **Installer** pin code is **5678**. Additional menu items and installer settings are now available.

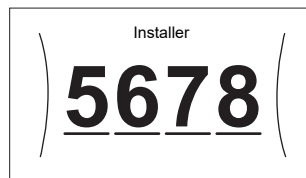

Advanced user pin code

The **Advanced user** pin code is **1234**. Additional menu items for the user are now visible.

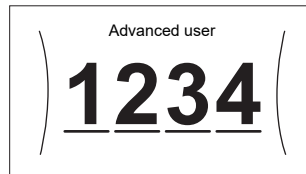

User pin code

The **User** pin code is **0000**.

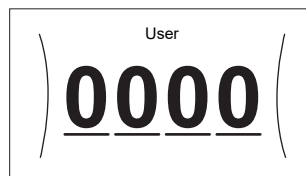

To access the installer settings

- 1 Set the user permission level to **Installer**.
- 2 Go to [9]: **Installer settings**.

To modify an overview setting

Example: Modify [1-01] from 15 to 20.

Most settings can be configured via the menu structure. If for any reason it is required to change a setting using the overview settings, then the overview settings can be accessed as follows:

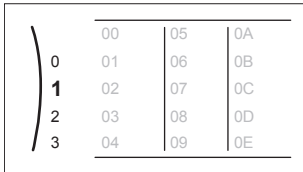
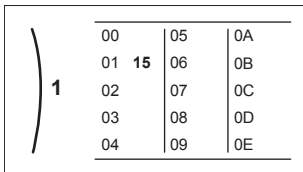
1	Set the user permission level to Installer . See " To change the user permission level " [▶ 104].	—
2	Go to [9.l]: Installer settings > Overview field settings .	🔍⋯○
3	Turn the left dial to select the first part of the setting and confirm by pressing the dial. 	🔍⋯○
4	Turn the left dial to select the second part of the setting 	🔍⋯○

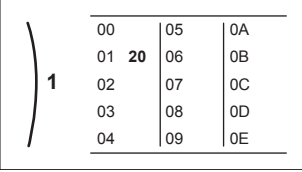
5	Turn the right dial to modify the value from 15 to 20.	○●●●●
		
6	Press the left dial to confirm the new setting.	●●●●○
7	Press the center button to go back to the home screen.	↑

i **INFORMATION**

When you change the overview settings and you go back to the home screen, the user interface will show a popup screen and request to restart the system.

When confirmed, the system will restart and recent changes will be applied.

10.1.2 To connect the PC cable to the switch box

Prerequisite: The EKPCAB4 kit is required.

- 1** Connect the USB connector of the cable to your PC.
- 2** Connect the plug of the cable to X10A on A1P (hydro PCB).

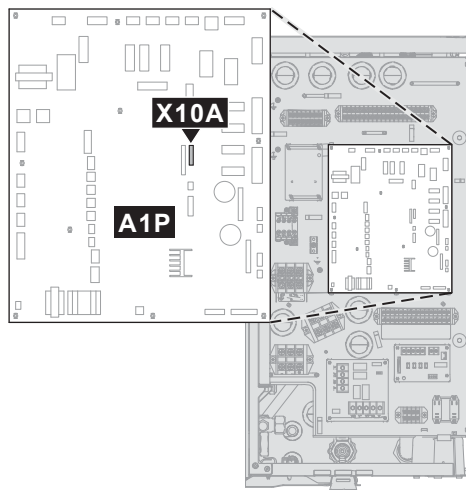

- 3** Pay special attention to the position of the plug!

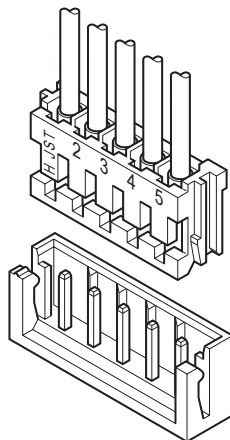

10.2 Configuration wizard

After first power ON of the system, the user interface starts a configuration wizard. Use this wizard to set the most important initial settings for the unit to run properly. If required, you can afterwards configure more settings. You can change all these settings via the menu structure.

You can find a short overview of the settings in the configuration here. All the settings can also be adjusted in the settings menu (use the breadcrumbs).

For the setting...		Refer to...
Language [7.1]		
Time/date [7.2]		
Hours	—	
Minutes		
Year		
Month		
Day		
Daylight savings time		
Format		
System		
Indoor unit type (read only)	"10.6.8 Installer settings" [▶ 161]	
Backup heater type [9.3.1]		
Emergency [9.5]		
Number of zones [4.4]	"10.6.5 Space heating/cooling" [▶ 146]	
Glycol Filled system (overview field setting [E-0D])	"10.6.8 Installer settings" [▶ 161]	
Bivalent [9.C]		
Backup heater (if applicable)		
Voltage [9.3.2]	"Backup heater" [▶ 162]	
Configuration [9.3.3]		
Capacity step 1 [9.3.4]		
Additional capacity step 2 [9.3.5] (if applicable)		
Main zone		

For the setting...		Refer to...
Emitter type [2.7]		"10.6.3 Main zone" [▶ 133]
Control [2.9]		
Setpoint mode [2.4]		
Heating WD curve [2.5] (if applicable)		
Cooling WD curve [2.6] (if applicable)		
Schedule [2.1]		
WD curve type [2.E]		
Additional zone (only if [4.4]=1)		
Emitter type [3.7]		"10.6.4 Additional zone" [▶ 142]
Control (read only) [3.9]		
Setpoint mode [3.4]		
Heating WD curve [3.5] (if applicable)		
Cooling WD curve [3.6] (if applicable)		
Schedule [3.1]		
WD curve type [3.C] (read only)		

10.3 Possible screens

10.3.1 Possible screens: Overview

The most common screens are as follows:

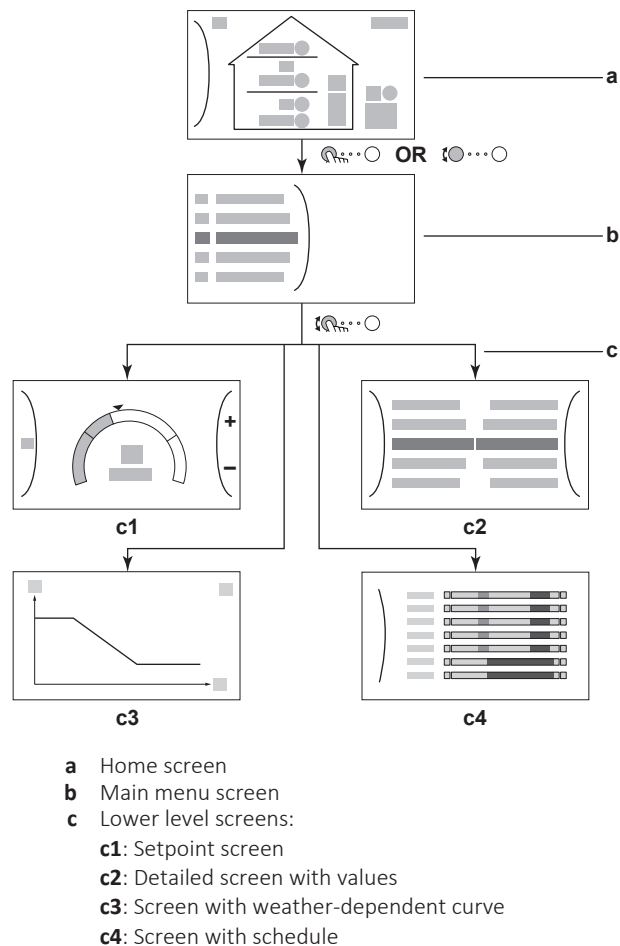





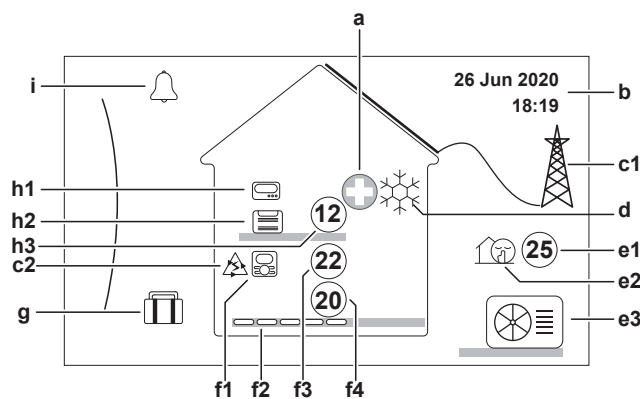

















10.3.2 Home screen

Press the button to go back to the home screen. You see an overview of the unit configuration and the room and setpoint temperatures. Only symbols applicable for your configuration are visible on the home screen.





Possible actions on this screen	
	Go through the list of the main menu.
	Go to the main menu screen.
?	Enable/disable breadcrumbs.

Item		Description
a	Emergency	
		Heat pump failure and system operates in Emergency mode or heat pump is forced off.
b	Current date and time	
c	Smart energy	
	c1	 Smart energy is available via solar panels or smart grid.
c2	 Smart energy is currently being used for space heating.	
d	Space operation mode	
	 Cooling	
	 Heating	
e	Outdoor / quiet mode	
	e1	 Measured outdoor temperature ^(a)
	e2	 Quiet mode active
	e3	 Outdoor unit
f	Main zone	
	f1	Installed room thermostat type:
		 Unit operation is decided based on the ambient temperature of the dedicated Human Comfort Interface (BRC1HHDA used as room thermostat).
		 Unit operation is decided by the external room thermostat (wired or wireless).
		— No room thermostat installed or set. Unit operation is decided based on the leaving water temperature regardless of the actual room temperature and/or heating demand of the room.
	f2	Installed heat emitter type:
		 Underfloor heating
		 Fancoil unit
		 Radiator
	f3	 Measured room temperature ^(a)
f4	 Leaving water temperature setpoint ^(a)	
g	Holiday mode	
	 Holiday mode active	

Item	Description
h	Additional zone
h1	Installed room thermostat type:
	Unit operation is decided by the external room thermostat (wired or wireless).
—	No room thermostat installed or set. Unit operation is decided based on the leaving water temperature regardless of the actual room temperature and/or heating demand of the room.
h2	Installed heat emitter type:
	Underfloor heating
	Fancoil unit
	Radiator
h3	 Leaving water temperature setpoint ^(a)
i	Malfunction
	A malfunction occurred.
	See " 14.4.1 To display the help text in case of a malfunction " [▶ 205] for more information.



^(a) If the corresponding operation (for example: space heating) is not active, the circle is greyed out.

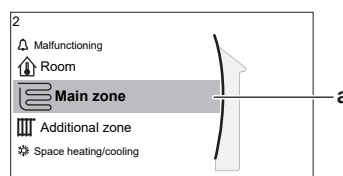

10.3.3 Main menu screen











Starting from the home screen, press () or turn () the left dial to open the main menu screen. From the main menu, you can access the different setpoint screens and submenus.



a Selected submenu

Possible actions on this screen	
	Go through the list.
	Enter the submenu.
?	Enable/disable breadcrumbs.

Submenu	Description
[0]  or  Malfunctioning	Restriction: Only displayed if a malfunction occurs. See " 14.4.1 To display the help text in case of a malfunction " [▶ 205] for more information.

Submenu		Description
[1]	 Room	Restriction: Only displayed if a dedicated Human Comfort Interface (BRC1HHDA used as room thermostat) is controlling the outdoor unit. Set the room temperature.
[2]	 Main zone	Shows the applicable symbol for your main zone emitter type. Set the leaving water temperature for the main zone.
[3]	 Additional zone	Restriction: Only displayed if there are two leaving water temperature zones. Shows the applicable symbol for your additional zone emitter type. Set the leaving water temperature for the additional zone (if present).
[4]	 Space heating/cooling	Shows the applicable symbol of your unit. Put the unit in heating mode or cooling mode. You cannot change the mode on cooling only models.
[7]	 User settings	Gives access to user settings such as holiday mode and quiet mode.
[8]	 Information	Displays data and information about the outdoor unit.
[9]	 Installer settings	Restriction: Only for the installer. Gives access to advanced settings.
[A]	 Commissioning	Restriction: Only for the installer. Perform tests and maintenance.
[B]	 User profile	Change the active user profile.
[C]	 Operation	Turn heating/cooling functionality on or off.
[D]	 Wireless gateway	Restriction: Only displayed if a wireless LAN (WLAN) is installed. Contains settings needed when configuring the ONECTA app.

10.3.4 Menu screen



Example:

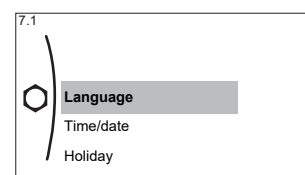

Possible actions on this screen	
	Go through the list.

Possible actions on this screen	
	Enter the submenu/setting.

10.3.5 Setpoint screen

The setpoint screen is displayed for screens describing system components that need a setpoint value.

Examples

[1] Room temperature screen

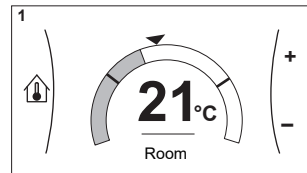

[2] Main zone screen

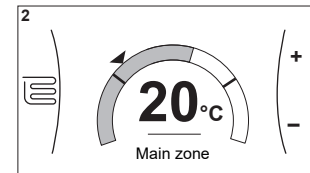

[3] Additional zone screen

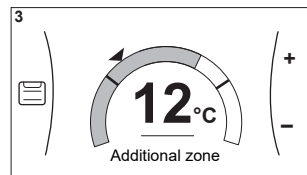

Explanation

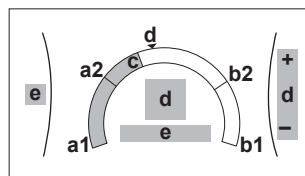

Possible actions on this screen	
	Go through the list of the submenu.
	Go to the submenu.
	Adjust and automatically apply the desired temperature.

Item	Description	
Minimum temperature limit	a1	Fixed by the unit
	a2	Restricted by the installer
Maximum temperature limit	b1	Fixed by the unit
	b2	Restricted by the installer
Current temperature	c	Measured by the unit
Desired temperature	d	Turn the right dial to increase/decrease.
Submenu	e	Turn or press the left dial to go to the submenu.

10.3.6 Detailed screen with values

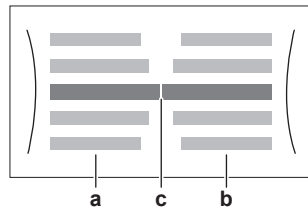

Example:

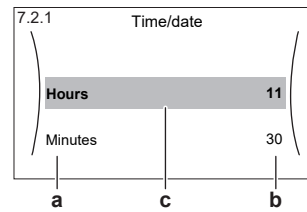

- a** Settings
- b** Values
- c** Selected setting and value

Possible actions on this screen	
	Go through the list of settings.
	Change the value.
	Go to the next setting.
	Confirm changes and proceed.

10.4 Preset values and schedules

10.4.1 Using preset values

About preset values

For some settings in the system, you can define preset values. You only need to set these values one time, then reuse the values in other screens such as the scheduling screen. If you later want to change the value, you only have to do it in one place.

Possible preset values

You can set the following user-defined preset values:

Preset value	Where used
Electricity prices under [7.5] User settings > Electricity price Restriction: Only applicable if Bivalent is enabled by the installer.	[7.5.1] High
	[7.5.2] Medium
	[7.5.3] Low
	You can use these preset values in [7.5.4] Schedule (weekly schedule screen for the energy prices). See " 10.4.4 Setting the energy prices " [▶ 121].

Additional to the user-defined preset values, the system also contains some system-defined preset values that you can use when programming schedules.

Example: In [7.4.2] **User settings** > **Quiet** > **Schedule** (weekly schedule for when the unit has to use which quiet mode level), you can use the following system-defined preset values: **Quiet/More quiet/Most quiet**.





10.4.2 Using and programming schedules

About schedules

Depending on your system layout and installer configuration, schedules for multiple controls may be available.

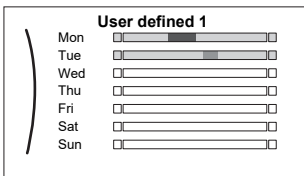
You can...	See...
Set if a specific control needs to act according to a schedule.	" Activation screen " in " Possible schedules " [▶ 115]
Select which schedule you currently want to use for a specific control. The system contains some predefined schedules. You can:	
Consult which schedule is currently selected.	" Schedule/Control " in " Possible schedules " [▶ 115]
Select another schedule if needed.	" To select which schedule you currently want to use " [▶ 115]
Program your own schedules if the predefined schedules are not satisfactory. The actions you can program are control specific.	<ul style="list-style-type: none"> ▪ "Possible actions" in "Possible schedules" [▶ 115] ▪ "10.4.3 Schedule screen: Example" [▶ 117]

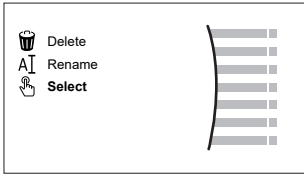
To select which schedule you currently want to use

1	Go to the schedule for the specific control. See " Schedule/Control " in " Possible schedules " [▶ 115]. Example: For the schedule for the desired room temperature in cooling mode, go to [1.3] Room > Cooling schedule.	
2	Select the name of the current schedule. 	
3	Select Select . 	
4	Select the schedule that you currently want to use.	

Possible schedules

The table contains the following information:

- **Schedule/Control:** This column shows you where you can consult the currently selected schedule for the specific control. If needed, you can:
 - Select another schedule. See "**To select which schedule you currently want to use**" [▶ 115].
 - Program your own schedule. See "**10.4.3 Schedule screen: Example**" [▶ 117].
- **Predefined schedules:** Number of available predefined schedules in the system for the specific control. If needed, you can program your own schedule.

- **Activation screen:** For most controls, a schedule is only effective if it activated in its corresponding activation screen. This entry shows you where to activate it.
- **Possible actions:** Actions you can use when programming a schedule. For most schedules, you can program up to 6 actions per day.

Schedule/Control	Description
<p>[1.2] Room > Heating schedule</p> <p>Schedule for the desired room temperature in heating mode.</p>	<p>Predefined schedules: 3</p> <p>Activation screen: [1.1] Schedule</p> <p>Possible actions: Temperatures within range.</p>
<p>[1.3] Room > Cooling schedule</p> <p>Schedule for the desired room temperature in cooling mode.</p>	<p>Predefined schedules: 1</p> <p>Activation screen: [1.1] Schedule</p> <p>Possible actions: Temperatures within range.</p>
<p>[2.2] Main zone > Heating schedule</p> <p>Schedule for the desired leaving water temperature for the main zone in heating mode.</p>	<p>Predefined schedules: 3</p> <p>Activation screen: [2.1] Schedule</p> <p>Possible actions:</p> <ul style="list-style-type: none"> ▪ In case of weather-dependent: Shift temperatures within range. ▪ Otherwise: Temperatures within range
<p>[2.3] Main zone > Cooling schedule</p> <p>Schedule for the desired leaving water temperature for the main zone in cooling mode.</p>	<p>Predefined schedules: 1</p> <p>Activation screen: [2.1] Schedule</p> <p>Possible actions:</p> <ul style="list-style-type: none"> ▪ In case of weather-dependent: Shift temperatures within range. ▪ Otherwise: Temperatures within range
<p>[3.2] Additional zone > Heating schedule</p> <p>Schedule for when the system is allowed to heat up the additional zone in heating mode.</p>	<p>Predefined schedules: 1</p> <p>Activation screen: [3.1] Schedule</p> <p>Possible actions:</p> <ul style="list-style-type: none"> ▪ Off: When the system is NOT allowed to heat up the additional zone. ▪ On: When the system is allowed to heat up the additional zone.
<p>[3.3] Additional zone > Cooling schedule</p> <p>Schedule for when the system is allowed to cool down the additional zone in cooling mode.</p>	<p>Predefined schedules: 1</p> <p>Activation screen: [3.1] Schedule</p> <p>Possible actions:</p> <ul style="list-style-type: none"> ▪ Off: When the system is NOT allowed to cool down the additional zone. ▪ On: When the system is allowed to cool down the additional zone.

Schedule/Control	Description
<p>[4.2] Space heating/cooling > Operation mode schedule</p> <p>Schedule (per month) for when to operate the unit in heating mode and when in cooling mode.</p>	<p>See "To set the space operation mode" [▶ 147].</p>
<p>[7.4.2] User settings > Quiet > Schedule</p> <p>Schedule for when the unit has to use which quiet mode level.</p>	<p>Predefined schedules: 1</p> <p>Activation screen: [7.4.1] Activation (only available to installers).</p> <p>Possible actions: You can use the following system-defined preset values:</p> <ul style="list-style-type: none"> ▪ Off ▪ Quiet ▪ More quiet ▪ Most quiet <p>See "About quiet mode" [▶ 157].</p>
<p>[7.5.4] User settings > Electricity price > Schedule</p> <p>Schedule for when a certain electricity tariff is valid.</p>	<p>Predefined schedules: 1</p> <p>Activation screen: Not applicable</p> <p>Possible actions: You can use the following system-defined preset values:</p> <ul style="list-style-type: none"> ▪ High ▪ Medium ▪ Low <p>See "10.4.4 Setting the energy prices" [▶ 121].</p>

10.4.3 Schedule screen: Example

This example shows how to set a room temperature schedule in cooling mode for the main zone.



INFORMATION

The procedures to program other schedules are similar.

To program the schedule: overview

Example: You want to program the following schedule:

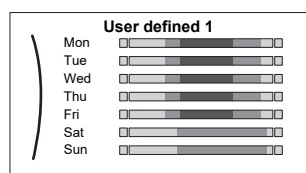



Prerequisite: The room temperature schedule is only available if room thermostat control is active. If leaving water temperature control is active, you can program the main zone schedule instead.





- 1 Go to the schedule.

- 2 (optional) Clear the content of the whole week schedule or the content of a selected day schedule.
- 3 Program the schedule for **Monday**.
- 4 Copy the schedule to the other weekdays.
- 5 Program the schedule for **Saturday** and copy it to **Sunday**.
- 6 Give the schedule a name.



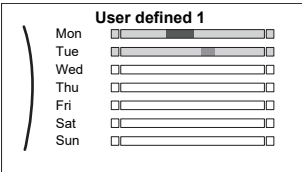

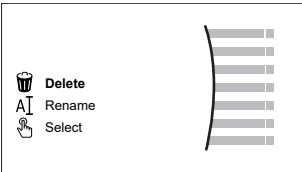
To go to the schedule

1	Go to [1.1]: Room > Schedule .	
2	Set scheduling to Yes .	
3	Go to [1.3]: Room > Cooling schedule	



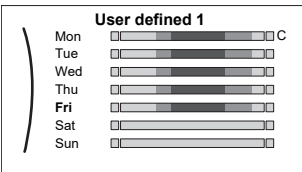

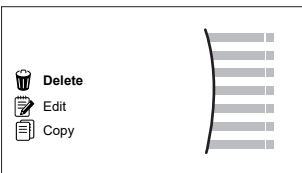

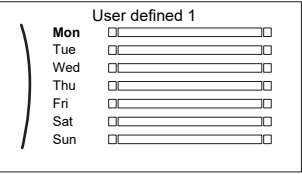

To clear the content of the week schedule

1	Select the name of the current schedule. 	
2	Select Delete . 	
3	Select OK to confirm.	

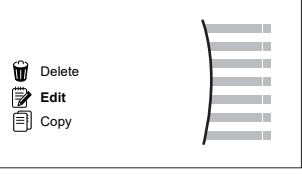

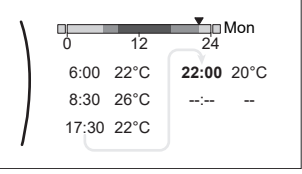

To clear the content of a day schedule



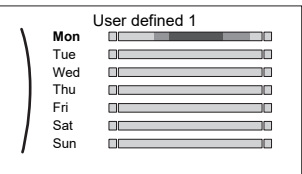

1	Select the day of which you want to clear the content. For example Friday 	
2	Select Delete . 	
3	Select OK to confirm.	

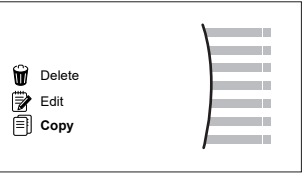
To program the schedule for Monday



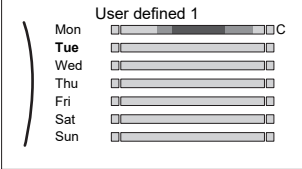

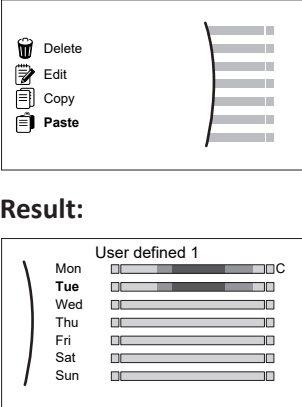

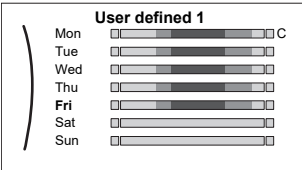

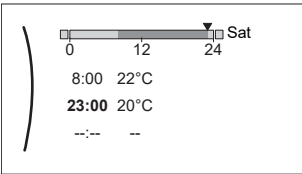

1	<p>Select Monday.</p> 	
2	<p>Select Edit.</p> 	
3	<p>Use the left dial to select an entry and edit the entry with the right dial. You can program up to 6 actions each day. On the bar, a high temperature has a darker colour than a low temperature.</p>  <p>Note: To clear an action, set its time as the time of the previous action.</p>	 
4	<p>Confirm the changes.</p> <p>Result: The schedule for Monday is defined. The value of the last action is valid until the next programmed action. In this example, Monday is the first day you programmed. Thus, the last programmed action is valid up to the first action of next Monday.</p>	

To copy the schedule to the other weekdays

1	<p>Select Monday.</p> 	
2	<p>Select Copy.</p>  <p>Result: Next to the copied day, "C" is displayed.</p>	

<p>3</p>	<p>Select Tuesday.</p> 	
<p>4</p>	<p>Select Paste.</p> 	
<p>5</p>	<p>Repeat this action for all other weekdays.</p> 	<p>—</p>

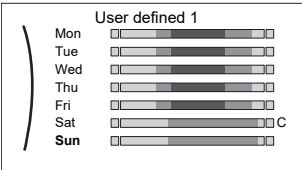
To program the schedule for Saturday and copy it to Sunday

<p>1</p>	<p>Select Saturday.</p>	
<p>2</p>	<p>Select Edit.</p>	
<p>3</p>	<p>Use the left dial to select an entry and edit the entry with the right dial.</p> 	 
<p>4</p>	<p>Confirm the changes.</p>	
<p>5</p>	<p>Select Saturday.</p>	
<p>6</p>	<p>Select Copy.</p>	
<p>7</p>	<p>Select Sunday.</p>	
<p>8</p>	<p>Select Paste.</p> <p>Result:</p> 	

To rename the schedule

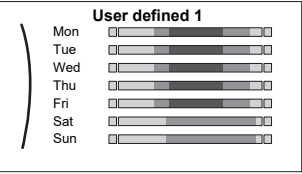
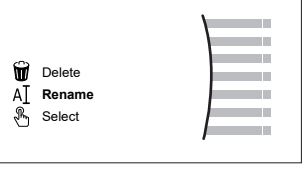
1	Select the name of the current schedule. 	
2	Select Rename . 	
3	(optional) To delete the current schedule name, browse through the character list until ← is displayed, then press to remove the previous character. Repeat for each character of the schedule name.	
4	To name the current schedule, browse through the character list and confirm the selected character. The schedule name can contain up to 15 characters.	
5	Confirm the new name.	



INFORMATION

Not all schedules can be renamed.

Usage example: You work in a 3-shift system

If you work in a 3-shift system, you can do the following:

- 1 Program 3 room temperature schedules and give them appropriate names.
Example: EarlyShift, DayShift and LateShift
- 2 Select the schedule that you currently want to use.

10.4.4 Setting the energy prices

In the system, you can set the following energy prices:

- a fixed gas price
- 3 electricity price levels
- a weekly schedule timer for electricity prices.

Example: How to set the energy prices on the user interface?

Price	Value in breadcrumb
Gas: 5.3 euro cents/kWh	[7.6]=5.3
Electricity: 12 euro cents/kWh	[7.5.1]=12

To set the gas price

1	Go to [7.6]: User settings > Gas price .	
2	Select the correct gas price.	
3	Confirm the changes.	

**INFORMATION**

Price value ranging from 0.00~990 valuta/kWh (with 2 significant values).

To set the electricity price

1	Go to [7.5.1]/[7.5.2]/[7.5.3]: User settings > Electricity price > High/Medium/Low.	
2	Select the correct electricity price.	
3	Confirm the changes.	
4	Repeat this for all three electricity prices.	—

**INFORMATION**

Price value ranging from 0.00~990 valuta/kWh (with 2 significant values).

**INFORMATION**

If no schedule is set, the **Electricity price for High** is taken into account.

To set the electricity price schedule timer

1	Go to [7.5.4]: User settings > Electricity price > Schedule.	
2	Program the selection using the scheduling screen. You can set the High, Medium and Low electricity prices according to your electricity supplier.	—
3	Confirm the changes.	

**INFORMATION**

The values correspond with the electricity price values for **High, Medium** and **Low** previously set. If no schedule is set, the electricity price for **High** is taken into account.

About energy prices in case of an incentive per kWh renewable energy

An incentive can be taken into account when setting the energy prices. Although the running cost can increase, the total operation cost, taking into account the reimbursement will be optimized.

**NOTICE**

Make sure to modify the setting of the energy prices at the end of the incentive period.

To set the gas price in case of an incentive per kWh renewable energy

Calculate the value for the gas price with the following formula:

- Actual gas price+(Incentive/kWh×0.9)

For the procedure to set the gas price, see "[To set the gas price](#)" [▶ 121].

To set the electricity price in case of an incentive per kWh renewable energy

Calculate the value for the electricity price with following formula:

- Actual electricity price+Incentive/kWh

For the procedure to set the electricity price, see ["To set the electricity price"](#) [▶ 122].

Example

This is an example and the prices and/or values used in this example are NOT accurate.

Data	Price/kWh
Gas price	4.08
Electricity price	12.49
Renewable heat incentive per kWh	5

Calculation of the gas price

Gas price=Actual gas price+(Incentive/kWh×0.9)

Gas price=4.08+(5×0.9)

Gas price=8.58

Calculation of the electricity price

Electricity price=Actual electricity price+Incentive/kWh

Electricity price=12.49+5

Electricity price=17.49

Price	Value in breadcrumb
Gas: 4.08 /kWh	[7.6]=8.6
Electricity: 12.49 /kWh	[7.5.1]=17

10.5 Weather-dependent curve

10.5.1 What is a weather-dependent curve?

Weather-dependent operation

The unit operates 'weather-dependent' if the desired leaving water temperature is determined automatically by the outdoor temperature. It therefore is connected to a temperature sensor on the North wall of the building. If the outdoor temperature drops or rises, the unit compensates instantly. Thus, the unit does not have to wait for feedback by the thermostat to increase or decrease the leaving water temperature. Because it reacts more quickly, it prevents high rises and drops of the indoor temperature.

Advantage

Weather-dependent operation reduces energy consumption.

Weather-dependent curve

To be able to compensate for differences in temperature, the unit relies on its weather-dependent curve. This curve defines how much the leaving water temperature must be at different outdoor temperatures. Because the slope of the curve depends on local circumstances such as climate and the insulation of the house, the curve can be adjusted by an installer or user.

Types of weather-dependent curve

There are 2 types of weather-dependent curves:

- 2-points curve
- Slope-offset curve

Which type of curve you use to make adjustments, depends on your personal preference. See "10.5.4 Using weather-dependent curves" [▶ 126].

Availability

The weather-dependent curve is available for:

- Main zone - Heating
- Main zone - Cooling
- Additional zone - Heating
- Additional zone - Cooling

i

INFORMATION

To operate weather-dependent, correctly configure the setpoint of the main zone and additional zone. See "10.5.4 Using weather-dependent curves" [▶ 126].

10.5.2 2-points curve

Define the weather-dependent curve with these two setpoints:

- Setpoint (X1, Y2)
- Setpoint (X2, Y1)

Example

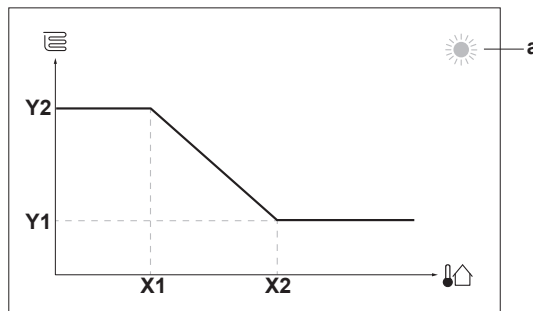

Item	Description
a	Selected weather-dependent zone: <ul style="list-style-type: none"> ▪ ☀: Main zone or additional zone heating ▪ ❄: Main zone or additional zone cooling
X1, X2	Examples of outdoor ambient temperature
Y1, Y2	Examples of desired leaving water temperature. The icon corresponds to the heat emitter for that zone: <ul style="list-style-type: none"> ▪ 🏠: Underfloor heating ▪ 🌀: Fan coil unit ▪ 🏠: Radiator

Possible actions on this screen	
🏠...○	Go through the temperatures.
○...🏠	Change the temperature.
○...🏠	Go to the next temperature.
🏠...○	Confirm changes and proceed.

10.5.3 Slope-offset curve

Slope and offset

Define the weather-dependent curve by its slope and offset:

- Change the **slope** to differently increase or decrease the temperature of the leaving water for different ambient temperatures. For example, if leaving water temperature is in general fine but at low ambient temperatures too cold, raise the slope so that leaving water temperature is heated increasingly more at decreasingly lower ambient temperatures.
- Change the **offset** to equally increase or decrease the temperature of the leaving water for different ambient temperatures. For example, if leaving water temperature is always a bit too cold at different ambient temperatures, shift the offset up to equally increase the leaving water temperature for all ambient temperatures.

Examples

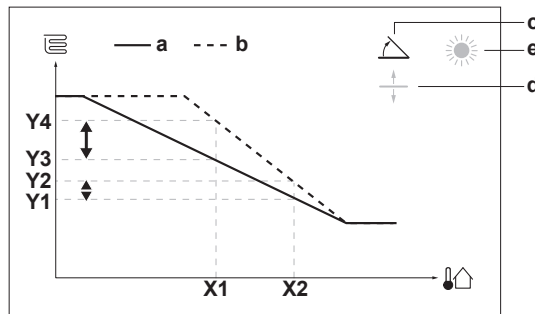

Weather-dependent curve when slope is selected:



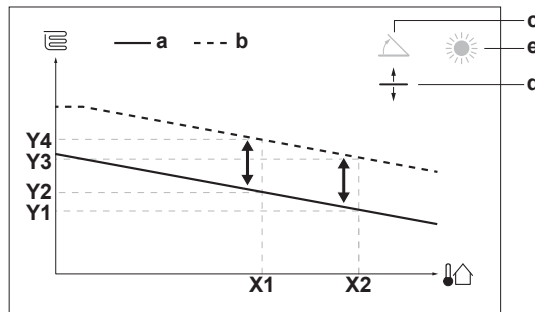



Weather-dependent curve when offset is selected:



Item	Description
a	WD curve before changes.
b	WD curve after changes (as example): <ul style="list-style-type: none"> ▪ When slope is changed, the new preferred temperature at X1 is unequally higher than the preferred temperature at X2. ▪ When offset is changed, the new preferred temperature at X1 is equally higher as the preferred temperature at X2.
c	Slope
d	Offset
e	Selected weather-dependent zone: <ul style="list-style-type: none"> ▪ ☀: Main zone or additional zone heating ▪ ❄: Main zone or additional zone cooling
X1, X2	Examples of outdoor ambient temperature

Item	Description
Y1, Y2, Y3, Y4	Examples of desired leaving water temperature. The icon corresponds to the heat emitter for that zone: <ul style="list-style-type: none"> ▪ : Underfloor heating ▪ : Fan coil unit ▪ : Radiator

Possible actions on this screen	
	Select slope or offset.
	Increase or decrease the slope/offset.
	When slope is selected: set slope and go to offset. When offset is selected: set offset.
	Confirm changes and return to the submenu.

10.5.4 Using weather-dependent curves

Configure weather-dependent curves as following:

To define the setpoint mode

To use the weather-dependent curve, you need to define the correct setpoint mode:

Go to setpoint mode ...	Set the setpoint mode to ...
Main zone – Heating	
[2.4] Main zone > Setpoint mode	WD heating, fixed cooling OR Weather dependent
Main zone – Cooling	
[2.4] Main zone > Setpoint mode	Weather dependent
Additional zone – Heating	
[3.4] Additional zone > Setpoint mode	WD heating, fixed cooling OR Weather dependent
Additional zone – Cooling	
[3.4] Additional zone > Setpoint mode	Weather dependent

To change the type of weather-dependent curve

To change the type for all zones (main + additional), go to [2.E] Main zone > WD curve type.

Viewing which type is selected is also possible via [3.C] Additional zone > WD curve type

To change the weather-dependent curve

Zone	Go to ...
Main zone – Heating	[2.5] Main zone > Heating WD curve
Main zone – Cooling	[2.6] Main zone > Cooling WD curve

Zone	Go to ...
Additional zone – Heating	[3.5] Additional zone > Heating WD curve
Additional zone – Cooling	[3.6] Additional zone > Cooling WD curve

**INFORMATION****Maximum and minimum setpoints**

You cannot configure the curve with temperatures that are higher or lower than the set maximum and minimum setpoints for that zone. When the maximum or minimum setpoint is reached, the curve flattens out.

To fine-tune the weather-dependent curve: slope-offset curve

The following table describes how to fine-tune the weather-dependent curve of a zone:

You feel ...		Fine-tune with slope and offset:	
At regular outdoor temperatures ...	At cold outdoor temperatures ...	Slope	Offset
OK	Cold	↑	—
OK	Hot	↓	—
Cold	OK	↓	↑
Cold	Cold	—	↑
Cold	Hot	↓	↑
Hot	OK	↑	↓
Hot	Cold	↑	↓
Hot	Hot	—	↓

To fine-tune the weather-dependent curve: 2-points curve

The following table describes how to fine-tune the weather-dependent curve of a zone:



You feel ...		Fine-tune with setpoints:			
At regular outdoor temperatures ...	At cold outdoor temperatures ...	Y2 ^(a)	Y1 ^(a)	X1 ^(a)	X2 ^(a)
OK	Cold	↑	—	↑	—
OK	Hot	↓	—	↓	—
Cold	OK	—	↑	—	↑
Cold	Cold	↑	↑	↑	↑
Cold	Hot	↓	↑	↓	↑
Hot	OK	—	↓	—	↓
Hot	Cold	↑	↓	↑	↓
Hot	Hot	↓	↓	↓	↓

^(a) See "10.5.2 2-points curve" [▶ 124].

10.6 Settings menu

You can set additional settings using the main menu screen and its submenus. The most important settings are presented here.

10.6.1 Malfunctioning

In case of a malfunction,  or  will appear on the home screen. To display the error code, open the menu screen and go to [0] **Malfunctioning**. Press **?** for more information about the error.

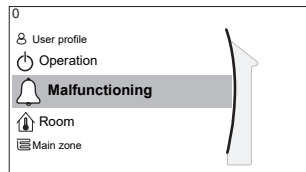

[0] Malfunctioning

10.6.2 Room

Overview

The following items are listed in the submenu:

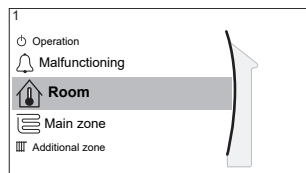

[1] Room

 Setpoint screen

[1.1] Schedule

[1.2] Heating schedule

[1.3] Cooling schedule

[1.4] Antifrost

[1.5] Setpoint range

[1.6] Room sensor offset

[1.7] Room sensor offset

[1.9] Room comfort setpoint

Setpoint screen

Control the room temperature of the main zone via setpoint screen [1] **Room**.

See "[10.3.5 Setpoint screen](#)" [▶ 113].

Schedule

Indicate if the room temperature is controlled according to a schedule or not.

#	Code	Description
[1.1]	N/A	<p>Schedule:</p> <ul style="list-style-type: none"> No: Room temperature is directly controlled by the user. Yes: Room temperature is controlled by a schedule and can be modified by the user.

Heating schedule

Only applicable for reversible models.

Define a heating schedule of the room temperature in [1.2] **Heating schedule**.

See "10.4.3 Schedule screen: Example" [▶ 117].

Cooling schedule

Applicable for all models.

Define a cooling schedule of the room temperature in [1.3] **Cooling schedule**.

See "10.4.3 Schedule screen: Example" [▶ 117].

Antifrost

[1.4] **Antifrost** prevents the room from getting too cold. This setting is applicable when [2.9] **Control=Room thermostat**, but also offers functionality for leaving water temperature control and external room thermostat control. In case of the latter two, **Antifrost** can be activated by setting field setting [2-06]=1.

Room frost protection, when enabled, is not guaranteed when there is no room thermostat that can activate the heat pump. This is the case when:

- [2.9] **Control=External room thermostat** and [C.2] **Space heating/cooling=Off**, or if
- [2.9] **Control=Leaving water**.

In the above cases, **Antifrost** will heat the space heating water to a reduced setpoint when the outdoor temperature is lower than 6°C.

Main zone unit control method [2.9]	Description
Leaving water temperature control ([C-07]=0)	Room frost protection is NOT guaranteed.
External room thermostat control ([C-07]=1)	Allow for the external room thermostat to take care of room frost protection: <ul style="list-style-type: none"> ▪ Set [C.2] Space heating/cooling=On.
Room thermostat control ([C-07]=2)	Allow for the dedicated Human Comfort Interface (BRC1HHDA used as room thermostat) to take care of room frost protection: <ul style="list-style-type: none"> ▪ Set antifrost [1.4.1] Activation=Yes. ▪ Set the temperature of the antifrost function in [1.4.2] Room setpoint.



NOTICE

If the system does NOT contain a backup heater, then:

- Make sure that the room antifrost control is activated ([2-06]=1).
- Do NOT change the default room antifrost temperature [2-05].
- Make sure that the water pipe freeze prevention is activated ([4-04]≠2).



INFORMATION

If a U4 error occurs, room frost protection is NOT guaranteed.

**NOTICE**

If the room **Antifrost** setting is active and a U4 error occurs, the unit will automatically start the **Antifrost** function via the backup heater. If the backup heater is not allowed for room frost protection during a U4 error, the room **Antifrost** setting **MUST** be disabled.

**NOTICE**

Room frost protection. Even if you turn OFF space heating/cooling operation ([C.2]: **Operation** > **Space heating/cooling**), room frost protection operation –if enabled– can still activate. However, for leaving water temperature control and external room thermostat control, the protection is **NOT** guaranteed.

For more detailed information about room frost protection in relation to the applicable unit control method, see the sections below.

Leaving water temperature control ([C-07]=0)

Under leaving water temperature control, room frost protection is **NOT** guaranteed. However, if room antifrost [2-06] is activated, limited frost protection by the unit is possible:

If...	Then...
<ul style="list-style-type: none"> ▪ Space heating/cooling=Off, and ▪ Outdoor ambient temperature drops below 6°C 	<ul style="list-style-type: none"> ▪ The unit will supply leaving water to the heat emitters to heat up the room again, and ▪ the temperature setpoint of the leaving water will be lowered.
<ul style="list-style-type: none"> ▪ Space heating/cooling=On, and ▪ Operation mode=Heating 	The unit will supply leaving water to the heat emitters to heat up the room according to normal logic.
<ul style="list-style-type: none"> ▪ Space heating/cooling=On, and ▪ Operation mode=Cooling 	There is no room frost protection.

External room thermostat control ([C-07]=1)

Under external room thermostat control, room frost protection is guaranteed by the external room thermostat, provided that:

- [C.2] **Space heating/cooling=On**, and
- [9.5.1] **Emergency=Automatic** or **auto SH normal/DHW off**.

However, if [1.4.1] **Antifrost** is activated, limited frost protection by the unit is possible.

In case of 1 leaving water temperature zone:

If...	Then...
<ul style="list-style-type: none"> ▪ Space heating/cooling=Off, and ▪ Outdoor ambient temperature drops below 6°C 	<ul style="list-style-type: none"> ▪ The unit will supply leaving water to the heat emitters to heat up the room again, and ▪ the temperature setpoint of the leaving water will be lowered.

If...	Then...
<ul style="list-style-type: none"> ▪ Space heating/cooling=On, and ▪ The external room thermostat is "Thermo OFF", and ▪ Outdoor temperature drops below 6°C 	<ul style="list-style-type: none"> ▪ The unit will supply leaving water to the heat emitters to heat up the room again, and ▪ the temperature setpoint of the leaving water will be lowered.
<ul style="list-style-type: none"> ▪ Space heating/cooling=On, and ▪ The external room thermostat is "Thermo ON" 	Room frost protection is guaranteed by the normal logic.

In case of 2 leaving water temperature zones:

If...	Then...
<ul style="list-style-type: none"> ▪ Space heating/cooling=Off, and ▪ Outdoor ambient temperature drops below 6°C 	<ul style="list-style-type: none"> ▪ The unit will supply leaving water to the heat emitters to heat up the room again, and ▪ the temperature setpoint of the leaving water will be lowered.
<ul style="list-style-type: none"> ▪ Space heating/cooling=On, and ▪ Operation mode=Heating, and ▪ The external room thermostat is "Thermo OFF", and ▪ Outdoor temperature drops below 6°C 	<ul style="list-style-type: none"> ▪ The unit will supply leaving water to the heat emitters to heat up the room again, and ▪ the temperature setpoint of the leaving water will be lowered.
<ul style="list-style-type: none"> ▪ Space heating/cooling=On, and ▪ Operation mode=Cooling 	There is no room frost protection.

Room thermostat control ([C-07]=2)

During room thermostat control, room frost protection [2-06] is guaranteed when activated. If so, and the room temperature drops below the room antifrost temperature [2-05], the unit will supply leaving water to the heat emitters to heat up the room again.

#	Code	Description
[1.4.1]	[2-06]	Activation: <ul style="list-style-type: none"> ▪ 0 No: Antifrost functionality is OFF. ▪ 1 Yes: Antifrost functionality is on.
[1.4.2]	[2-05]	Room setpoint: <ul style="list-style-type: none"> ▪ 4°C~16°C



INFORMATION

When the dedicated Human Comfort Interface (BRC1HHDA used as room thermostat) is disconnected (because of incorrect wiring or damage of the cable), then room frost protection is NOT guaranteed.

**NOTICE**

If **Emergency** is set to **Manual** ([9.5.1]=0), and the unit is triggered to start emergency operation, the unit will stop and needs to be recovered manually via the user interface. To recover operation manually, go to the **Malfunctioning** main menu screen, and confirm emergency operation before starting.

Room frost protection is active even if the user does not confirm emergency operation.

Setpoint range

Only applicable in room thermostat control.

To save energy by preventing overheating or undercooling the room, you can limit the range of the room temperature for heating and/or cooling.

**NOTICE**

When adjusting the room temperature ranges, all desired room temperatures are also adjusted to guarantee they are between the limits.

#	Code	Description
[1.5.1]	[3-07]	Heating minimum
[1.5.2]	[3-06]	Heating maximum
[1.5.3]	[3-09]	Cooling minimum
[1.5.4]	[3-08]	Cooling maximum

Room sensor offset

Only applicable in room thermostat control.

To calibrate the (external) room temperature sensor, give an offset to the value of the room thermistor as measured by the Human Comfort Interface (BRC1HHDA used as room thermostat) or by the external room sensor. The setting can be used to compensate for situations where the Human Comfort Interface or the external room sensor cannot be installed at the ideal location.

See "6.6 Setting up an external temperature sensor" [▶ 47].

#	Code	Description
[1.6]	[2-0A]	Room sensor offset (Human Comfort Interface (BRC1HHDA used as room thermostat)): Offset on the actual room temperature measured by the Human Comfort Interface. <ul style="list-style-type: none"> ▪ $-5^{\circ}\text{C}\sim 5^{\circ}\text{C}$, step 0.5°C
[1.7]	[2-09]	Room sensor offset (external room sensor option): Only applicable if the external room sensor option is installed and configured. <ul style="list-style-type: none"> ▪ $-5^{\circ}\text{C}\sim 5^{\circ}\text{C}$, step 0.5°C

Room comfort setpoint

Restriction: Only applicable if:

- Smart Grid is enabled ([9.8.4]=**Smart grid**), and
- Room buffering is enabled ([9.8.7]=**Yes**)

If room buffering is enabled, the extra energy from photovoltaic panels is buffered in the DHW tank and in the space heating/cooling circuit (i.e. heat up or cool down the room). With the room comfort setpoints (cooling/heating) you can modify the maximum/minimum setpoints that will be used when buffering the extra energy in the space heating/cooling circuit.

#	Code	Description
[1.9.1]	[9-0A]	Heating comfort setpoint ▪ [3-07]~[3-06]°C
[1.9.2]	[9-0B]	Cooling comfort setpoint ▪ [3-09]~[3-08]°C

10.6.3 Main zone

Overview

The following items are listed in the submenu:

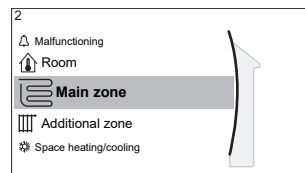

[2] Main zone

Setpoint screen

[2.1] Schedule

[2.2] Heating schedule

[2.3] Cooling schedule

[2.4] Setpoint mode

[2.5] Heating WD curve

[2.6] Cooling WD curve

[2.7] Emitter type

[2.8] Setpoint range

[2.9] Control

[2.A] Ext thermostat type

[2.B] Delta T

[2.C] Modulation

[2.E] WD curve type

Setpoint screen

Control the leaving water temperature for the main zone via setpoint screen [2] **Main zone**.

See "[10.3.5 Setpoint screen](#)" [▶ 113].

Schedule

Indicate if the temperature of the leaving water is defined according to a schedule or not.

Influence of the LWT setpoint mode [2.4] is as follows:

- In **Fixed** LWT setpoint mode, the scheduled actions consist of desired leaving water temperatures, either preset or custom.
- In **Weather dependent** LWT setpoint mode, the scheduled actions consist of desired shift actions, either preset or custom.

#	Code	Description
[2.1]	N/A	Schedule: <ul style="list-style-type: none"> ▪ 0: No ▪ 1: Yes

Heating schedule

Define a heating temperature schedule for the main zone via [2.2] **Heating schedule**.

See "10.4.3 Schedule screen: Example" [▶ 117].

Cooling schedule

Define a cooling temperature schedule for the main zone via [2.3] **Cooling schedule**.

See "10.4.3 Schedule screen: Example" [▶ 117].

Setpoint mode

Define the setpoint mode:

- **Fixed:** the desired leaving water temperature does not depend on the outdoor ambient temperature.
- In **WD heating, fixed cooling** mode, the desired leaving water temperature:
 - depends on the outdoor ambient temperature for heating
 - does NOT depend on the outdoor ambient temperature for cooling
- In **Weather dependent** mode, the desired leaving water temperature depends on the outdoor ambient temperature.

#	Code	Description
[2.4]	N/A	Setpoint mode: <ul style="list-style-type: none"> ▪ Fixed ▪ WD heating, fixed cooling ▪ Weather dependent

When weather dependent operation is active, low outdoor temperatures will result in warmer water and vice versa. During weather dependent operation, the user can shift the water temperature up or down by a maximum of 10°C.

Heating WD curve

Set weather-dependent heating for the main zone (if [2.4]=1 or 2):

#	Code	Description
[2.5]	[1-00] [1-01] [1-02] [1-03]	<p>Set weather-dependent heating:</p> <p>Note: There are 2 methods to set the weather dependent curve. See "10.5.2 2-points curve" [▶ 124] and "10.5.3 Slope-offset curve" [▶ 125]. Both curve types require 4 field settings to be configured according to the figure below.</p> <ul style="list-style-type: none"> ▪ T_t: Target leaving water temperature (main zone) ▪ T_a: Outdoor temperature ▪ [1-00]: Low outdoor ambient temperature. $-40^{\circ}\text{C}\sim+5^{\circ}\text{C}$ ▪ [1-01]: High outdoor ambient temperature. $10^{\circ}\text{C}\sim25^{\circ}\text{C}$ ▪ [1-02]: Desired leaving water temperature when the outdoor temperature equals or drops below the low ambient temperature. $[9-01]^{\circ}\text{C}\sim[9-00]^{\circ}\text{C}$ <p>Note: This value should be higher than [1-03] as for low outdoor temperatures warmer water is required.</p> <ul style="list-style-type: none"> ▪ [1-03]: Desired leaving water temperature when the outdoor temperature equals or rises above the high ambient temperature. $[9-01]^{\circ}\text{C}\sim\min(45, [9-00])^{\circ}\text{C}$ <p>Note: This value should be lower than [1-02] as for high outdoor temperatures less warm water is required.</p>

Cooling WD curve

Set weather-dependent cooling for the main zone (if [2.4]=2):

#	Code	Description
[2.6]	[1-06] [1-07] [1-08] [1-09]	<p>Set weather-dependent cooling:</p> <p>Note: There are 2 methods to set the weather dependent curve. See "10.5.2 2-points curve" [▶ 124] and "10.5.3 Slope-offset curve" [▶ 125]. Both curve types require 4 field settings to be configured according to the figure below.</p> <ul style="list-style-type: none"> ▪ T_t: Target leaving water temperature (main zone) ▪ T_a: Outdoor temperature ▪ [1-06]: Low outdoor ambient temperature. 10°C~25°C ▪ [1-07]: High outdoor ambient temperature. 25°C~43°C ▪ [1-08]: Desired leaving water temperature when the outdoor temperature equals or drops below the low ambient temperature. [9-03]°C~[9-02]°C <p>Note: This value should be higher than [1-09] as for low outdoor temperatures less cold water is required.</p> <ul style="list-style-type: none"> ▪ [1-09]: Desired leaving water temperature when the outdoor temperature equals or rises above the high ambient temperature. [9-03]°C~[9-02]°C <p>Note: This value should be lower than [1-08] as for high outdoor temperatures colder water is required.</p>

Emitter type

Heating up or cooling down the main zone can take longer. This depends on:

- The water volume of the system
- The heater emitter type of the main zone

The setting **Emitter type** can compensate for a slow or a quick heating/cooling system during the heat up/cool down cycle. In room thermostat control, **Emitter type** influences the maximum modulation of the desired leaving water temperature, and the possibility for usage of the automatic cooling/heating changeover based on the indoor ambient temperature.

It is important to set **Emitter type** correctly and in accordance with your system layout. The target delta T for the main zone depends on it.

#	Code	Description
[2.7]	[2-0C]	Emitter type: <ul style="list-style-type: none"> ▪ 0: Underfloor heating ▪ 1: Fancoil unit ▪ 2: Radiator

The setting **Emitter type** influences the space heating setpoint range and the target delta T in heating as follows:

Description	Space heating setpoint range	Target delta T in heating
0: Underfloor heating	Maximum 55°C	Variable (see [2.B.1])
1: Fancoil unit	Maximum 55°C	Variable (see [2.B.1])
2: Radiator	Maximum 65°C	Variable (see [2.B.1])



NOTICE

The maximum setpoint in space heating depends on the emitter type as can be seen in above table. If there are 2 water temperature zones, then the maximum setpoint is the maximum of the 2 zones.



NOTICE

NOT configuring the system in the following way can cause damage to the heat emitters. If there are 2 zones, it is important that in heating:

- the zone with the lowest water temperature is configured as the main zone, and
- the zone with the highest water temperature is configured as the additional zone.



NOTICE

If there are 2 zones and the emitter types are wrongly configured, water of high temperature can be sent towards a low temperature emitter (underfloor heating). To avoid this:

- Install an aquastat/thermostatic valve to avoid too high temperatures towards a low temperature emitter.
- Make sure you set the emitter types for the main zone [2.7] and for the additional zone [3.7] correctly in accordance with the connected emitter.



NOTICE

Average emitter temperature = Leaving water temperature – (Delta T)/2

This means that for a same leaving water temperature setpoint, the average emitter temperature of radiators is lower than that of underfloor heating because of a bigger delta T.

Example radiators: $40 - 10 / 2 = 35^{\circ}\text{C}$

Example underfloor heating: $40 - 5 / 2 = 37.5^{\circ}\text{C}$

To compensate, you can:

- Increase the weather-dependent curve desired temperatures [2.5].
- Enable leaving water temperature modulation and increase the maximum modulation [2.C].

Setpoint range

To prevent a wrong (i.e. too hot or too cold) leaving water temperature for the main leaving water temperature zone, limit its temperature range.

NOTICE

In case of a floor heating application it is important to limit the:

- maximum leaving water temperature at heating operation according to the specifications of the floor heating installation.
- the minimum leaving water temperature at cooling operation to 18~20°C to prevent condensation on the floor.

NOTICE

- When adjusting the leaving water temperature ranges, all desired leaving water temperatures are also adjusted to guarantee they are between the limits.
- Always balance between the desired leaving water temperature with the desired room temperature and/or the capacity (according to the design and selection of the heat emitters). The desired leaving water temperature is the result of several settings (preset values, shift values, weather-dependent curves, modulation). As a result, too high or too low leaving water temperatures could occur which lead to overtemperatures or capacity shortage. By limiting the leaving water temperature range to adequate values (depending on the heat emitter), such situations can be avoided.

Example: In heating mode, leaving water temperatures must be sufficiently higher than the room temperatures. To avoid that the room cannot heat up as desired, set the minimum leaving water temperature to 28°C.

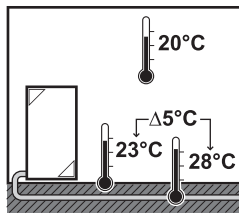

#	Code	Description
Leaving water temperature range for the main leaving water temperature zone (= the leaving water temperature zone with the lowest leaving water temperature in heating operation and the highest leaving water temperature in cooling operation)		
[2.8.1]	[9-01]	Heating minimum: <ul style="list-style-type: none"> ▪ 15°C~37°C
[2.8.2]	[9-00]	Heating maximum: <ul style="list-style-type: none"> ▪ [2-0C]=2 (emitter type main zone = radiator) 37°C~60°C ▪ Else: 37°C~55°C
[2.8.3]	[9-03]	Cooling minimum: <ul style="list-style-type: none"> ▪ 5°C~18°C
[2.8.4]	[9-02]	Cooling maximum: <ul style="list-style-type: none"> ▪ 18°C~22°C

Control

Define how the operation of the unit is controlled.

Control	In this control...
Leaving water	Unit operation is decided based on the leaving water temperature regardless the actual room temperature and/or heating or cooling demand of the room.
External room thermostat	Unit operation is decided by the external thermostat or equivalent (e.g. fan coil units).
Room thermostat	Unit operation is decided based on the ambient temperature of the dedicated Human Comfort Interface (BRC1HHDA used as room thermostat).

#	Code	Description
[2.9]	[C-07]	<ul style="list-style-type: none"> ▪ 0: Leaving water ▪ 1: External room thermostat ▪ 2: Room thermostat

Ext thermostat type

Only applicable in external room thermostat control.



NOTICE

If an external room thermostat is used, the external room thermostat will control the room frost protection. However, the room frost protection is only possible if [C.2] Space heating/cooling=On.

#	Code	Description
[2.A]	[C-05]	<p>External room thermostat type for the main zone:</p> <ul style="list-style-type: none"> ▪ 1: 1 contact: The used external room thermostat can only send a thermo ON/OFF condition. There is no separation between heating or cooling demand. The room thermostat is connected to only 1 digital input (X2M/35). ▪ 2: 2 contacts: The used external room thermostat can send a separate heating/cooling thermo ON/OFF condition. The room thermostat is connected to 2 digital inputs (X2M/35 and X2M/34). <p>Select this value in case of a connection to the wired (EKRTWA) or wireless (EKRTR1, EKRTTB) room thermostat</p>

Leaving water temperature: Delta T

In heating for the main zone, the target delta T (temperature difference) depends on the selected emitter type for the main zone.

Delta T is the absolute value of the temperature difference between the leaving water and entering water.

The unit is designed to support underfloor loops operation. The recommended leaving water temperature for underfloor loops is 35°C. In such case, the unit will realize a temperature difference of 5°C, which means that the entering water temperature is around 30°C.

Depending on the installed type of heat emitters (radiators, fan coil units, underfloor loops) or situation, you can change the difference between entering and leaving water temperature.

Note: The pump will regulate its flow to keep the delta T. In some special cases, the measured delta T can differ from the set value.



INFORMATION

When only the backup heater is active in heating, delta T will be controlled according to the fixed capacity of the backup heater. It is possible that this delta T is different from the selected target delta T.



INFORMATION

In heating, the target delta T will only be achieved after some operation time, when the setpoint is being reached, because of the big difference between leaving water temperature setpoint and inlet temperature at startup.



INFORMATION

If the main zone or the additional zone has a heating demand, and this zone is equipped with radiators, then the target delta T that the unit will use in heating operation will be equal to the temperature set in [2.B].

If the zones are not equipped with radiators, then in heating the unit will give priority to the target delta T for the additional zone, if there is a heating demand in the additional zone.

In cooling the unit will give priority to the target delta T for the additional zone, if there is a cooling demand in the additional zone.

#	Code	Description
[2.B.1]	[1-OB]	<p>Delta T heating: A minimum temperature difference is required for proper operation of heat emitters in heating mode.</p> <ul style="list-style-type: none"> ▪ If [2-0C]=2: 10°C~12°C - Else: 3°C~12°C
[2.B.2]	[1-OD]	<p>Delta T cooling: A minimum temperature difference is required for proper operation of heat emitters in cooling mode.</p> <ul style="list-style-type: none"> ▪ 3°C~10°C

Leaving water temperature: Modulation

Only applicable in case of room thermostat control.

When using the room thermostat functionality, the customer needs to set the desired room temperature. The unit will supply hot water to the heat emitters and the room will be heated.

Additionally, also the desired leaving water temperature must be configured: if **Modulation** is enabled, the unit automatically calculates the desired leaving water temperature. These calculations are based on:

- the preset temperatures, or

- the desired weather-dependent temperatures (if weather-dependent is enabled)

Moreover, with **Modulation** enabled, the desired leaving water temperature is lowered or raised in function of the desired room temperature and the difference between the actual and the desired room temperature. This results in:

- stable room temperatures, exactly matching the desired temperature (higher comfort level)
- less on/off cycles (lower noise level, higher comfort and higher efficiency)
- water temperatures as low as possible to match the desired temperature (higher efficiency)

If **Modulation** is disabled, set the desired leaving water temperature via [2] **Main zone**.

#	Code	Description
[2.C.1]	[8-05]	Modulation: <ul style="list-style-type: none"> 0 No (disabled) 1 Yes (enabled) Note: The desired leaving water temperature can only be read out on the user interface.
[2.C.2]	[8-06]	Max modulation: <ul style="list-style-type: none"> 0°C~10°C This is the temperature value by which the desired leaving water temperature is increased or decreased.



INFORMATION

When leaving water temperature modulation is enabled, the weather-dependent curve needs to be set to a higher position than [8-06] plus the minimum leaving water temperature setpoint required to reach a stable condition on the comfort setpoint for the room. To increase efficiency, modulation can lower the leaving water setpoint. By setting the weather-dependent curve to a higher position, it cannot drop below the minimum setpoint. See the illustration below.

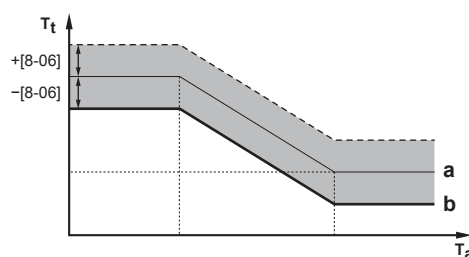

- a Weather-dependent curve
- b Minimum leaving water temperature setpoint required to reach a stable condition on the comfort setpoint for the room.

WD curve type

The weather-dependent curve can be defined using the **2-points** method or the **Slope-Offset** method.

See "[10.5.2 2-points curve](#)" [▶ 124] and "[10.5.3 Slope-offset curve](#)" [▶ 125].

#	Code	Description
[2.E]	N/A	<ul style="list-style-type: none"> 2-points Slope-Offset

10.6.4 Additional zone

Overview

The following items are listed in the submenu:

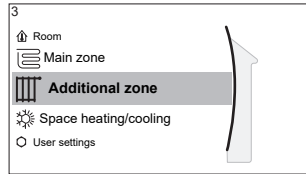
**[3] Additional zone**

Setpoint screen

[3.1] Schedule

[3.2] Heating schedule

[3.3] Cooling schedule

[3.4] Setpoint mode

[3.5] Heating WD curve

[3.6] Cooling WD curve

[3.7] Emitter type

[3.8] Setpoint range

[3.9] Control

[3.A] Ext thermostat type

[3.B] Delta T

[3.C] WD curve type

Setpoint screen

Control the leaving water temperature for the additional zone via setpoint screen [3] **Additional zone**.

See "[10.3.5 Setpoint screen](#)" [▶ 113].

Schedule

Indicates if the desired leaving water temperature is according to a schedule.

See "[10.6.3 Main zone](#)" [▶ 133].

#	Code	Description
[3.1]	N/A	Schedule: <ul style="list-style-type: none"> ▪ No ▪ Yes

Heating schedule

Define a heating temperature schedule for the additional zone via [3.2] **Heating schedule**.

See "[10.4.3 Schedule screen: Example](#)" [▶ 117].

Cooling schedule

Define a cooling temperature schedule for the additional zone via [3.3] **Cooling schedule**.

See "[10.4.3 Schedule screen: Example](#)" [▶ 117].

Setpoint mode

The setpoint mode of the additional zone can be independently set from the setpoint mode of the main zone.

See "[Setpoint mode](#)" [▶ 134].

#	Code	Description
[3.4]	N/A	Setpoint mode: <ul style="list-style-type: none"> ▪ Fixed ▪ WD heating, fixed cooling ▪ Weather dependent

Heating WD curve

Set weather-dependent heating for the additional zone (if [3.4]=1 or 2):

#	Code	Description
[3.5]	[0-00] [0-01] [0-02] [0-03]	<p>Set weather-dependent heating:</p> <p>Note: There are 2 methods to set the weather dependent curve. See "10.5.2 2-points curve" [▶ 124] and "10.5.3 Slope-offset curve" [▶ 125]. Both curve types require 4 field settings to be configured according to the figure below.</p> <ul style="list-style-type: none"> ▪ T_t: Target leaving water temperature (additional zone) ▪ T_a: Outdoor temperature ▪ [0-03]: Low outdoor ambient temperature. – 40°C~+5°C ▪ [0-02]: High outdoor ambient temperature. 10°C~25°C ▪ [0-01]: Desired leaving water temperature when the outdoor temperature equals or drops below the low ambient temperature. [9-05]°C~[9-06]°C <p>Note: This value should be higher than [0-00] as for low outdoor temperatures warmer water is required.</p> <ul style="list-style-type: none"> ▪ [0-00]: Desired leaving water temperature when the outdoor temperature equals or rises above the high ambient temperature. [9-05]~min(45, [9-06])°C <p>Note: This value should be lower than [0-01] as for high outdoor temperatures less warm water is required.</p>

Cooling WD curve

Set weather-dependent cooling for the additional zone (if [3.4]=2):

#	Code	Description
[3.6]	[0-04] [0-05] [0-06] [0-07]	<p>Set weather-dependent cooling:</p> <p>Note: There are 2 methods to set the weather dependent curve. See "10.5.2 2-points curve" [▶ 124] and "10.5.3 Slope-offset curve" [▶ 125]. Both curve types require 4 field settings to be configured according to the figure below.</p> <ul style="list-style-type: none"> ▪ T_t: Target leaving water temperature (additional zone) ▪ T_a: Outdoor temperature ▪ [0-07]: Low outdoor ambient temperature. 10°C~25°C ▪ [0-06]: High outdoor ambient temperature. 25°C~43°C ▪ [0-05]: Desired leaving water temperature when the outdoor temperature equals or drops below the low ambient temperature. [9-07]°C~[9-08]°C <p>Note: This value should be higher than [0-04] as for low outdoor temperatures less cold water is required.</p> <ul style="list-style-type: none"> ▪ [0-04]: Desired leaving water temperature when the outdoor temperature equals or rises above the high ambient temperature. [9-07]°C~[9-08]°C <p>Note: This value should be lower than [0-05] as for high outdoor temperatures colder water is required.</p>

Emitter type

For more information about Emitter type, see "[10.6.3 Main zone](#)" [▶ 133].

#	Code	Description
[3.7]	[2-0D]	<p>Emitter type:</p> <ul style="list-style-type: none"> ▪ 0: Underfloor heating ▪ 1: Fancoil unit ▪ 2: Radiator

The setting of the emitter type has an influence on the space heating setpoint range and the target delta T in heating as follows:

Emitter type Additional zone	Space heating setpoint range [9-05]~[9-06]	Target delta T in heating [1-0C]
0: Underfloor heating	Maximum 55°C	Variable (see [3.B.1])
1: Fancoil unit	Maximum 55°C	Variable (see [3.B.1])
2: Radiator	Maximum 65°C	Variable (see [3.B.1])

Setpoint range

For more information about **Setpoint range**, see "[10.6.3 Main zone](#)" [▶ 133].

#	Code	Description
Leaving water temperature range for the additional leaving water temperature zone (= the leaving water temperature zone with the highest leaving water temperature in heating operation and the lowest leaving water temperature in cooling operation)		
[3.8.1]	[9-05]	Heating minimum: 15°C~37°C
[3.8.2]	[9-06]	Heating maximum <ul style="list-style-type: none"> ▪ [2-0D]=2 (emitter type additional zone = radiator) 37°C~60°C ▪ Else: 37°C~55°C
[3.8.3]	[9-07]	Cooling minimum <ul style="list-style-type: none"> ▪ 5°C~18°C
[3.8.4]	[9-08]	Cooling maximum <ul style="list-style-type: none"> ▪ 18°C~22°C

Control

The control type for the additional zone is read only. It is determined by the control type of the main zone.

See "[10.6.3 Main zone](#)" [▶ 133].

#	Code	Description
[3.9]	N/A	Control: <ul style="list-style-type: none"> ▪ Leaving water if the control type of the main zone is Leaving water. ▪ External room thermostat if the control type of the main zone is: <ul style="list-style-type: none"> - External room thermostat,or - Room thermostat.

Ext thermostat type

Only applicable in external room thermostat control.

Also see "[10.6.3 Main zone](#)" [▶ 133].

#	Code	Description
[3.A]	[C-06]	External room thermostat type for the additional zone: <ul style="list-style-type: none"> 1: 1 contact. Connected to only 1 digital input (X2M/35a) 2: 2 contacts. Connected to 2 digital inputs (X2M/34a and X2M/35a)

Leaving water temperature: Delta T

For more information, see "10.6.3 Main zone" [▶ 133].

#	Code	Description
[3.B.1]	[1-0C]	Delta T heating: A minimum temperature difference is required for the good operation of heat emitters in heating mode. <ul style="list-style-type: none"> If [2-0C]=2: 10°C~12°C - Else: 3°C~12°C
[3.B.2]	[1-0E]	Delta T cooling: A minimum temperature difference is required for the good operation of heat emitters in cooling mode. <ul style="list-style-type: none"> 3°C~10°C

WD curve type

There are 2 methods to define the weather-dependent curves:

- 2-points (see "10.5.2 2-points curve" [▶ 124])
- Slope-Offset (see "10.5.3 Slope-offset curve" [▶ 125])

In [2.E] **WD curve type**, you can choose which method you want to use.

In [3.C] **WD curve type**, the chosen method is shown read-only (same value as in [2.E]).

#	Code	Description
[2.E] / [3.C]	N/A	<ul style="list-style-type: none"> 2-points Slope-Offset

10.6.5 Space heating/cooling



INFORMATION

Heating is only applicable in case of reversible models.

Overview

The following items are listed in the submenu:

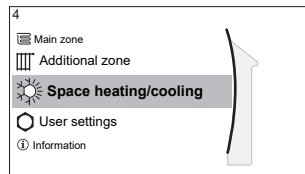

[4] Space heating/cooling

- [4.1] Operation mode
- [4.2] Operation mode schedule
- [4.3] Operation range
- [4.4] Number of zones
- [4.5] Pump operation mode
- [4.6] Unit type
- [4.7] Pump limitation
- [4.9] Pump outside range
- [4.A] Increase around 0°C
- [4.B] Overshoot
- [4.C] Antifrost

About space operation modes

Your unit can be a cooling or a heating/cooling model:

- If your unit is a cooling model, it can cool down a space.
- If your unit is a heating/cooling model, it can both heat up and cool down a space. You have to tell the system which operation mode to use.

To determine if a heating/cooling heat pump model is installed

1	Go to [4]: Space heating/cooling.	
2	Check if [4.1] Operation mode is listed and editable. If so, a heating/cooling heat pump model is installed.	

To tell the system which space operation to use, you can:

You can...	Location
Check which space operation mode is currently used.	Home screen
Set the space operation mode permanently.	Main menu
Restrict automatic changeover according to a monthly schedule.	

To check which space operation mode is currently used

The space operation mode is displayed on the home screen:

- When the unit is in heating mode, the icon is shown.
- When the unit is in cooling mode, the icon is shown.

The status indicator shows if the unit is currently in operation:

- When the unit is not in operation, the status indicator will show a blue pulsation with an interval of approximately 5 seconds.
- While the unit is in operation, the status indicator will light up blue constantly.

To set the space operation mode





1	Go to [4.1]: Space heating/cooling > Operation mode	
----------	---	--

2	Select one of the following options: <ul style="list-style-type: none"> ▪ Heating: Only heating mode ▪ Cooling: Only cooling mode ▪ Automatic: The operation mode changes automatically between heating and cooling based on the outdoor temperature. Restricted per month according to the Operation mode schedule [4.2]. 	
----------	---	---

When **Automatic** is selected, the unit switches its operation mode, based on the **Operation mode schedule** [4.2]. In this schedule, the end user indicates which operation is allowed for each month.

To restrict automatic changeover according to a schedule

Conditions: You set the space operation mode to **Automatic**.

1	Go to [4.2]: Space heating/cooling > Operation mode schedule .	
2	Select a month.	
3	For each month, select an option: <ul style="list-style-type: none"> ▪ Reversible: Not restricted ▪ Heating only: Restricted ▪ Cooling only: Restricted 	
4	Confirm the changes.	

Example: Changeover restrictions

When	Restriction
During cold season. Example: October, November, December, January, February and March.	Heating only
During warm season. Example: June, July and August.	Cooling only
In-between. Example: April, May and September.	Reversible

The unit determines its operation mode by the outdoor temperature if:

- **Operation mode=Automatic**, and
- **Operation mode schedule=Reversible**.

The unit determines its operation mode in such a way that it will always stay within the following operation ranges:

- **Space heating off temperature**
- **Space cooling off temperature**

The outdoor temperature is time-averaged. If the outdoor temperature drops, the operation mode will switch to heating and vice versa.

If the outdoor temperature is between the **Space heating off temperature** and the **Space cooling off temperature**, the operation mode remains unchanged.

Operation range

Depending on the average outdoor temperature, the operation of the unit in space heating or space cooling is prohibited.

#	Code	Description
[4.3.1]	[4-02]	Space heating off temperature: When the averaged outdoor temperature rises above this value, space heating is turned off. ^(a) <ul style="list-style-type: none"> 14°C~35°C
[4.3.2]	[F-01]	Space cooling off temperature: When the averaged outdoor temperature drops below this value, space cooling is turned off. ^(a) <ul style="list-style-type: none"> 10°C~35°C

^(a) This setting is also used in automatic heating/cooling changeover.



NOTICE

Maximum value [4-02]. For models without integrated backup heater:

- Default value [4-02]=22°C. You can change this value, but do NOT exceed the maximum value.
- If the external backup heater kit is installed: Maximum value [4-02]=35°C
- If the external backup heater kit is NOT installed: Maximum value [4-02]=25°C

Exception: If the system is configured in room thermostat control with one leaving water temperature zone and quick heat emitters, the operation mode will change based on the measured indoor temperature. Besides the desired heating/cooling room temperature, the installer sets a hysteresis value (e.g. when in heating, this value is related to the desired cooling temperature) and an offset value (e.g. when in heating, this value is related to the desired heating temperature).

Example: A unit is configured as following:

- Desired room temperature in heating mode: 22°C
- Desired room temperature in cooling mode: 24°C
- Hysteresis value: 1°C
- Offset: 4°C

Changeover from heating to cooling will occur when the room temperature rises above the maximum of the desired cooling temperature added by the hysteresis value (thus $24+1=25^{\circ}\text{C}$) and the desired heating temperature added by the offset value (thus $22+4=26^{\circ}\text{C}$).

Oppositely, changeover from cooling to heating will occur when the room temperature drops below the minimum of the desired heating temperature subtracted by the hysteresis value (thus $22-1=21^{\circ}\text{C}$) and the desired cooling temperature subtracted by the offset value (thus $24-4=20^{\circ}\text{C}$)

Guard timer to prevent too frequent changing from heating to cooling and vice versa.

#	Code	Description
		Changeover settings related to the indoor temperature. Only applicable when Automatic is selected and the system is configured in room thermostat control with 1 leaving water temperature zone and quick heat emitters.

#	Code	Description
N/A	[4-0B]	<p>Hysteresis: ensures that changeover is only done when necessary.</p> <p>The space operation only changes from heating to cooling when the room temperature rises above the desired cooling temperature added by the hysteresis value.</p> <ul style="list-style-type: none"> Range: 1°C~10°C
N/A	[4-0D]	<p>Offset: ensures that the active desired room temperature is always reached.</p> <p>In heating mode, the space operation only changes when the room temperature rises above the desired heating temperature added by the offset value.</p> <ul style="list-style-type: none"> Range: 1°C~10°C

Number of zones

The system can supply leaving water to up to 2 water temperature zones. During configuration, the number of water zones must be set.

i **INFORMATION**
Mixing station. If your system layout contains 2 LWT zones, you need to install a mixing station in front of the main LWT zone.

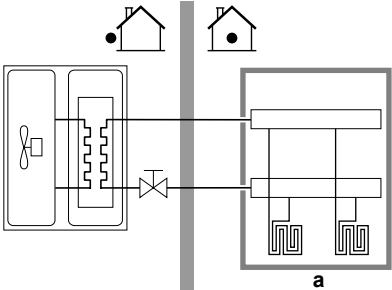
#	Code	Description
[4.4]	[7-02]	<ul style="list-style-type: none"> 0: Single zone <p>Only one leaving water temperature zone:</p>  <p>a Main LWT zone</p>

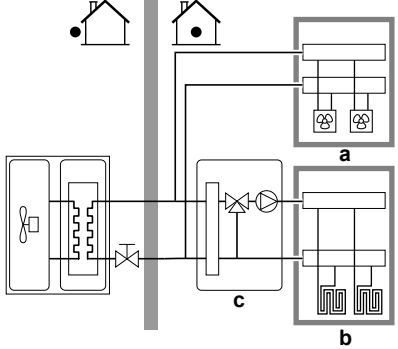
#	Code	Description
[4.4]	[7-02]	<ul style="list-style-type: none"> 1: Dual zone <p>Two leaving water temperature zones. The main leaving water temperature zone consists of the higher load heat emitters and a mixing station to achieve the desired leaving water temperature. In heating:</p>  <p>a Additional LWT zone: Highest temperature b Main LWT zone: Lowest temperature c Mixing station</p>

**NOTICE**

NOT configuring the system in the following way can cause damage to the heat emitters. If there are 2 zones, it is important that in heating:

- the zone with the lowest water temperature is configured as the main zone, and
- the zone with the highest water temperature is configured as the additional zone.

**NOTICE**

If there are 2 zones and the emitter types are wrongly configured, water of high temperature can be sent towards a low temperature emitter (underfloor heating). To avoid this:

- Install an aquastat/thermostatic valve to avoid too high temperatures towards a low temperature emitter.
- Make sure you set the emitter types for the main zone [2.7] and for the additional zone [3.7] correctly in accordance with the connected emitter.

Pump operation mode

When the space heating/cooling operation is OFF, the pump is always OFF. When space heating/cooling operation is ON, you have the choice between these operation modes:

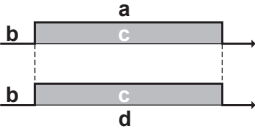
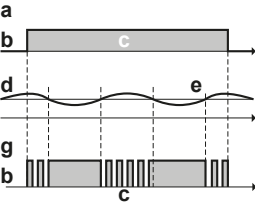
#	Code	Description
[4.5]	[F-0D]	<p>Pump operation mode:</p> <ul style="list-style-type: none"> 0 Continuous: Continuous pump operation, regardless of thermo ON or OFF condition. Remark: Continuous pump operation requires more energy than sample or request pump operation.  <p>a Space heating/cooling control b Off c On d Pump operation</p>
[4.5]	[F-0D]	<ul style="list-style-type: none"> 1 Sample: The pump is ON when there is heating or cooling demand as the leaving water temperature has not yet reached the desired temperature yet. When thermo OFF condition occurs, the pump runs every 3 minutes to check the water temperature and demand heating or cooling if necessary. Remark: Sample is ONLY available in leaving water temperature control.  <p>a Space heating/cooling control b Off c On d LWT temperature e Actual f Desired g Pump operation</p>

#	Code	Description
[4.5]	[F-0D]	<ul style="list-style-type: none"> ▪ 2 Request: Pump operation based on request. <p>Example: Using a room thermostat and thermostat creates thermo ON/OFF condition.</p> <p>Remark: NOT available in leaving water temperature control.</p> <p>The diagram shows five horizontal bars representing different control signals over time. Bar 'a' is a long bar with a 'c' label inside. Bar 'b' is a shorter bar below 'a'. Bar 'd' is a bar with two segments, each labeled 'c', with a 'b' label between them. Bar 'e' is a bar with two segments, each labeled 'c'. Vertical dashed lines indicate the start and end of the 'b' and 'd' segments.</p> <p>a Space heating/cooling control b Off c On d Heating demand (by external room thermostat or room thermostat) e Pump operation</p>

Unit type

In this part of the menu it can be read out which type of unit is used:

#	Code	Description
[4.6]	N/A	<p>Unit type:</p> <ul style="list-style-type: none"> ▪ 1 Cooling only ▪ 3 Reversible

Pump limitation

Pump speed limitation [9-0D] defines the maximum pump speed. In normal conditions, the default setting should NOT be modified. The pump speed limitation will be overruled when the flow rate is in the range of the minimum flow (error 7H).

In most cases, instead of using [9-0D], you can prevent flow noises by performing hydraulic balancing.

#	Code	Description
[4.7]	[9-0D]	<p>Pump limitation</p> <p>Possible values: see below.</p>

Possible values:

Value	Description
0	No limitation
1~4	<p>General limitation. There is limitation in all conditions. The required delta T control and comfort are NOT guaranteed.</p> <ul style="list-style-type: none"> ▪ 1: 90% pump speed ▪ 2: 80% pump speed ▪ 3: 70% pump speed ▪ 4: 60% pump speed

Value	Description
5~8	<p>Limitation when no actuators. When there is no heating output, the pump speed limitation is applicable. When there is heating output, the pump speed is only determined by delta T in relation to the required capacity. With this limitation range, delta T is possible and the comfort is guaranteed.</p> <p>During sampling operation the pump runs for a short time to measure the water temperatures, which indicate if operation is required or not.</p> <ul style="list-style-type: none"> ▪ 5: 90% pump speed during sampling ▪ 6: 80% pump speed during sampling ▪ 7: 70% pump speed during sampling ▪ 8: 60% pump speed during sampling

The maximum values depend on the unit type:

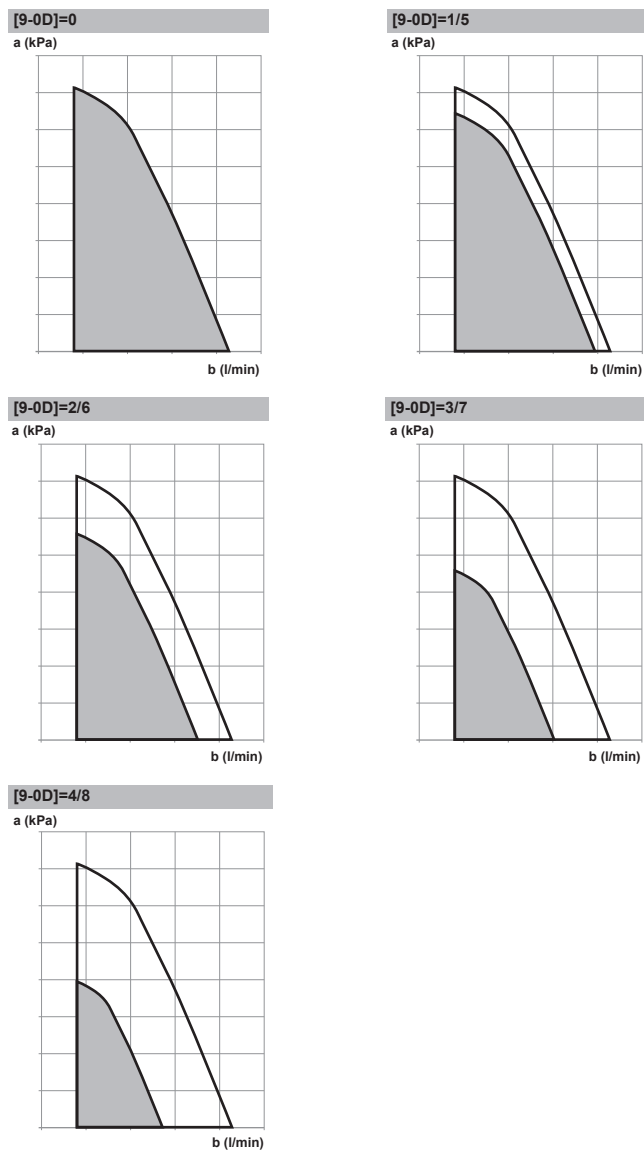

- a** External static pressure
- b** Water flow rate

Pump outside range

When the pump operation function is disabled the pump will stop if the outdoor temperature is higher than the value set by the **Space heating off temperature** [4-02] or if the outdoor temperature drops below the value set by the **Space cooling off temperature** [F-01]. When the pump operation is enabled, the pump operation is possible at all outdoor temperatures.

#	Code	Description
[4.9]	[F-00]	Pump operation: <ul style="list-style-type: none"> 0: Disabled if outdoor temperature is higher than [4-02] or lower than [F-01] depending on heating/cooling operation mode. 1: Possible at all outdoor temperatures.

Increase around 0°C

Use this setting to compensate for possible heat losses of the building due to the evaporation of melted ice or snow. (e.g. in cold region countries).

In heating operation, the desired leaving water temperature is locally increased around an outdoor temperature of 0°C. This compensation can be selected when using an absolute or a weather dependent desired temperature (see illustration below).

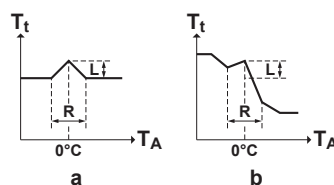

a Absolute desired LWT
b Weather dependent desired LWT

#	Code	Description
[4.A]	[D-03]	Increase around 0°C: <ul style="list-style-type: none"> 0: No 1: increase 2°C, span 4°C 2: increase 4°C, span 4°C 3: increase 2°C, span 8°C 4: increase 4°C, span 8°C

Overshoot

Restriction: This function is only applicable in heating mode.

This function defines how much the water temperature may rise above the desired leaving water temperature before the compressor stops. The compressor will start up again when the leaving water temperature drops below the desired leaving water temperature.

#	Code	Description
[4.B]	[9-04]	Overshoot: <ul style="list-style-type: none"> 1°C~4°C

Undershoot

Restriction: This function is only applicable in cooling mode during compressor startup. It is NOT applicable for stable operation.

This function defines how much the water temperature may drop below the desired leaving water temperature before the compressor stops. The compressor will start up again when the leaving water temperature rises above the desired leaving water temperature.

#	Code	Description
N/A	[9-09]	Undershoot: ▪ 1°C~18°C

Antifrost

Antifrost [1.4] or [4.C] prevents the room from getting too cold. For more information about room frost protection, see "10.6.2 Room" [▶ 128].

10.6.6 User settings

Overview

The following items are listed in the submenu:

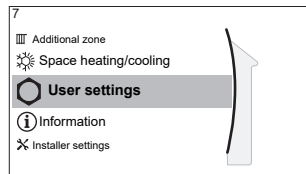

- [7] User settings
- [7.1] Language
- [7.2] Time/date
- [7.3] Holiday
- [7.4] Quiet
- [7.5] Electricity price
- [7.6] Gas price

Language

#	Code	Description
[7.1]	N/A	Language

Time/date

#	Code	Description
[7.2]	N/A	Set the local time and date

INFORMATION

By default, daylight savings time is enabled and clock format is set to 24 hours. These settings can be changed during initial configuration or via the menu structure [7.2]: User settings > Time/date.

Holiday

About holiday mode

During your holiday, you can use the holiday mode to deviate from your normal schedules without having to change them. While holiday mode is active, space heating/cooling operation will be turned off. Room frost protection and water pipe freeze prevention will remain active.

Typical workflow









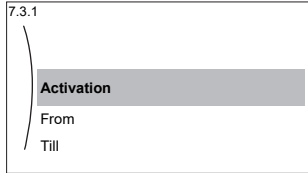

Using holiday mode typically consists of the following stages:

- 1 Activating the holiday mode.
- 2 Setting the starting date and ending date of your holiday.

To check if holiday mode is activated and/or running

If  is displayed on the home screen, holiday mode is active.

To configure the holiday

1	Activate the holiday mode.	—
	<ul style="list-style-type: none"> ▪ Go to [7.3.1]: User settings > Holiday > Activation. 	
	<ul style="list-style-type: none"> ▪ Select On. 	
2	Set the first day of your holiday.	—
	<ul style="list-style-type: none"> ▪ Go to [7.3.2]: From. 	
	<ul style="list-style-type: none"> ▪ Select a date. 	 
	<ul style="list-style-type: none"> ▪ Confirm the changes. 	
3	Set the last day of your holiday.	—
	<ul style="list-style-type: none"> ▪ Go to [7.3.3]: Till. 	
	<ul style="list-style-type: none"> ▪ Select a date. 	 
	<ul style="list-style-type: none"> ▪ Confirm the changes. 	

Quiet

About quiet mode

You can use quiet mode to decrease the sound of the outdoor unit. However, this also decreases the heating/cooling capacity of the system. There are multiple quiet mode levels.

The installer can:

- Completely deactivate quiet mode
- Manually activate a quiet mode level
- Enable the user to program a quiet mode schedule

If enabled by the installer, the user can program a quiet mode schedule.







INFORMATION

If the outdoor temperature is below zero, we recommend to NOT use the most quiet level.

To check if quiet mode is active

If  is displayed on the home screen, quiet mode is active.

To use quiet mode

1	Go to [7.4.1]: User settings > Quiet > Mode.	
2	Do one of the following:	—
If you want to...		Then...
Completely deactivate quiet mode	Select Off . Result: The unit never runs in quiet mode. The user cannot change this.	
Manually activate a quiet mode level	Select Manual .	
	Go to [7.4.3] Level and select the applicable quiet mode level. Example: Most quiet. Result: The unit always runs in the selected quiet mode level. The user cannot change this.	
Enable the user to program a quiet mode schedule	Select Automatic . Result: The unit runs in quiet mode according to a schedule. The user (or you) can program the schedule in [7.4.2] Schedule . For more information about scheduling, see " 10.4.3 Schedule screen: Example " [▶ 117].	

Electricity prices and gas price

Only applicable in combination with the bivalent function. See also "[Bivalent](#)" [▶ 173].



#	Code	Description
[7.5.1]	N/A	Electricity price > High
[7.5.2]	N/A	Electricity price > Medium
[7.5.3]	N/A	Electricity price > Low
[7.6]	N/A	Gas price



INFORMATION

Electricity price can only be set when bivalent is ON ([9.C.1] or [C-02]). These values can only be set in menu structure [7.5.1], [7.5.2] and [7.5.3]. Do NOT use overview settings.

To set the gas price

1	Go to [7.6]: User settings > Gas price.	
2	Select the correct gas price.	
3	Confirm the changes.	



INFORMATION

Price value ranging from 0.00~990 valuta/kWh (with 2 significant values).

To set the electricity price

1	Go to [7.5.1]/[7.5.2]/[7.5.3]: User settings > Electricity price > High/Medium/Low.	
2	Select the correct electricity price.	
3	Confirm the changes.	
4	Repeat this for all three electricity prices.	—



INFORMATION

Price value ranging from 0.00~990 valuta/kWh (with 2 significant values).



INFORMATION

If no schedule is set, the **Electricity price** for **High** is taken into account.

To set the electricity price schedule timer

1	Go to [7.5.4]: User settings > Electricity price > Schedule.	
2	Program the selection using the scheduling screen. You can set the High , Medium and Low electricity prices according to your electricity supplier.	—
3	Confirm the changes.	



INFORMATION

The values correspond with the electricity price values for **High**, **Medium** and **Low** previously set. If no schedule is set, the electricity price for **High** is taken into account.

About energy prices in case of an incentive per kWh renewable energy

An incentive can be taken into account when setting the energy prices. Although the running cost can increase, the total operation cost, taking into account the reimbursement will be optimized.



NOTICE

Make sure to modify the setting of the energy prices at the end of the incentive period.

To set the gas price in case of an incentive per kWh renewable energy

Calculate the value for the gas price with the following formula:

- Actual gas price+(Incentive/kWh×0.9)

For the procedure to set the gas price, see ["To set the gas price"](#) [▶ 158].

To set the electricity price in case of an incentive per kWh renewable energy

Calculate the value for the electricity price with following formula:

- Actual electricity price+Incentive/kWh

For the procedure to set the electricity price, see ["To set the electricity price"](#) [▶ 159].

Example

This is an example and the prices and/or values used in this example are NOT accurate.

Data	Price/kWh
Gas price	4.08
Electricity price	12.49
Renewable heat incentive per kWh	5

Calculation of the gas price

Gas price=Actual gas price+(Incentive/kWh×0.9)

Gas price=4.08+(5×0.9)

Gas price=8.58

Calculation of the electricity price

Electricity price=Actual electricity price+Incentive/kWh

Electricity price=12.49+5

Electricity price=17.49

Price	Value in breadcrumb
Gas: 4.08 /kWh	[7.6]=8.6
Electricity: 12.49 /kWh	[7.5.1]=17

10.6.7 Information

Overview

The following items are listed in the submenu:

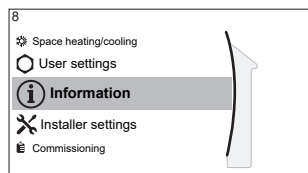

[8] Information

- [8.1] Energy data
- [8.2] Malfunction history
- [8.3] Dealer information
- [8.4] Sensors
- [8.5] Actuators
- [8.6] Operation modes
- [8.7] About
- [8.8] Connection status
- [8.9] Running hours
- [8.A] Reset

Dealer information

The installer can fill in his contact number here.

#	Code	Description
[8.3]	N/A	Number that users can call in case of problems.

Reset

Reset the configuration settings stored in the MMI (user interface delivered as accessory).

Example: Energy meterings, holiday settings.



INFORMATION

This does not reset the configuration settings and field settings of the hydro module of the outdoor unit.

#	Code	Description
[8.A]	N/A	Reset the MMI EEPROM to factory default

Possible read-out information

In menu...	You can read out...
[8.1] Energy data	Produced energy, consumed electricity, and consumed gas
[8.2] Malfunction history	Malfunction history
[8.3] Dealer information	Contact/helpdesk number
[8.4] Sensors	Room temperature, outside temperature, leaving water temperature,...
[8.5] Actuators	Status/mode of each actuator Example: Unit pump ON/OFF
[8.6] Operation modes	Current operation mode Example: Defrost/oil return mode
[8.7] About	Version information about the system
[8.8] Connection status	Information about the connection status of the unit, the room thermostat and WLAN.
[8.9] Running hours	Running hours of specific system components

10.6.8 Installer settings

Overview

The following items are listed in the submenu:

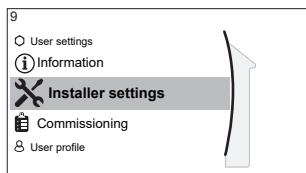

[9] Installer settings

- [9.1] Configuration wizard
- [9.3] Backup heater
- [9.5] Emergency
- [9.7] Water pipe freeze prevention
- [9.8] Benefit kWh power supply
- [9.9] Power consumption control
- [9.A] Energy metering
- [9.B] Sensors
- [9.C] Bivalent
- [9.D] Alarm output
- [9.E] Auto restart
- [9.F] Power saving function
- [9.G] Disable protections
- [9.H] Forced defrost
- [9.I] Overview field settings
- [9.N] Export MMI settings

Configuration wizard

After first power ON of the system, the user interface will guide you using the configuration wizard. This way you can set the most important initial settings. This way the unit will be able to run properly. Afterwards, more detailed settings can be done via the menu structure if required.

To restart the configuration wizard, go to **Installer settings > Configuration wizard** [9.1].

Backup heater

Besides the type of backup heater, the voltage, configuration and capacity must be set on the user interface.

The capacities for the different steps of the backup heater must be set for the energy metering and/or power consumption feature to work properly. When measuring the resistance value of each heater, you can set the exact heater capacity and this will lead to more accurate energy data.

Backup heater type

#	Code	Description
[9.3.1]	[E-03]	<ul style="list-style-type: none"> ▪ 0: No heater ▪ 1: External heater

Voltage

#	Code	Description
[9.3.2]	[5-0D]	<ul style="list-style-type: none"> ▪ 0: 230V, 1ph ▪ 2: 400V, 3ph

Configuration

The backup heater can be configured in different ways. It can be chosen to have a 1-step only backup heater or a backup heater with 2 steps. If 2 steps, the capacity of the second step depends on this setting. It can also be chosen to have a higher capacity of the second step in emergency.

#	Code	Description
[9.3.3]	[4-0A]	<ul style="list-style-type: none"> ▪ 0: Relay 1 ▪ 1: Relay 1 / Relay 1+2 ▪ 2: Relay 1 / Relay 2 ▪ 3: Relay 1 / Relay 2 Emergency Relay 1+2



INFORMATION

Settings [9.3.3] and [9.3.5] are linked. Changing one setting influences the other. If you change one, check if the other is still as expected.



INFORMATION

During normal operation, the capacity of the second step of the backup heater at nominal voltage is equal to [6-03]+[6-04].



INFORMATION

If [4-0A]=3 and emergency mode is active, the power usage of the backup heater is maximal and equal to $2 \times [6-03] + [6-04]$.

Capacity step 1

#	Code	Description
[9.3.4]	[6-03]	<ul style="list-style-type: none"> ▪ The capacity of the first step of the backup heater at nominal voltage.

Additional capacity step 2

#	Code	Description
[9.3.5]	[6-04]	<ul style="list-style-type: none"> ▪ The capacity difference between the second and first step of the backup heater at nominal voltage. Nominal value depends on backup heater configuration.

Equilibrium

#	Code	Description
[9.3.6]	[5-00]	<p>Equilibrium: Deactivate backup heater (or external backup heat source in case of a bivalent system) above the equilibrium temperature for space heating?</p> <ul style="list-style-type: none"> ▪ 0: No ▪ 1: Yes
[9.3.7]	[5-01]	<p>Equilibrium temperature: Outdoor temperature below which operation of the backup heater (or external backup heat source in case of a bivalent system) is allowed.</p> <p>Range: $-15^{\circ}\text{C} \sim 35^{\circ}\text{C}$</p>

Operation

#	Code	Description
[9.3.8]	[4-00]	Backup heater operation: <ul style="list-style-type: none"> ▪ 0: Restricted ▪ 1: Allowed ▪ 2: Only DHW: Do NOT use.

Emergency

Emergency

When the heat pump fails to operate, the optional external backup heater kit can serve as an emergency heater. It then takes over the heat load either automatically or by manual interaction.

- When **Emergency** is set to **Automatic** (or **auto SH normal/DHW off**)⁽¹⁾ and a heat pump failure occurs, the backup heater automatically takes over the heat load.
- When **Emergency** is set to **Manual** and a heat pump failure occurs, the space heating stops.

To manually recover it via the user interface, go to the **Malfunctioning** main menu screen and confirm whether the backup heater can take over the heat load or not.

- When **Emergency** is set to **auto SH reduced/DHW off** (or **auto SH reduced/DHW on**)⁽²⁾ and a heat pump failure occurs, space heating is reduced.

Similarly as in **Manual** mode, the unit can take the full load with the backup heater if the user activates this via the **Malfunctioning** main menu screen.

To keep energy consumption low, we recommend to set **Emergency** to **auto SH reduced/DHW off** if the house is unattended for longer periods.

#	Code	Description
[9.5.1]	[4-06]	<ul style="list-style-type: none"> ▪ 0: Manual ▪ 1: Automatic ▪ 2: auto SH reduced/DHW on Do NOT use.^(a) ▪ 3: auto SH reduced/DHW off ▪ 4: auto SH normal/DHW off Do NOT use.^(a)

^(a) These settings are not needed because there is no domestic hot water.



INFORMATION

The auto emergency setting can be set in the menu structure of the user interface only.

⁽¹⁾ **auto SH normal/DHW off** has the same effect as **Automatic**, but should NOT be used because there is no domestic hot water.

⁽²⁾ **auto SH reduced/DHW on** has the same effect as **auto SH reduced/DHW off**, but should NOT be used because there is no domestic hot water.

**INFORMATION**

If a heat pump failure occurs and **Emergency** is set to **Manual**, the following functions will remain active even if the user does NOT confirm emergency operation:

- Room frost protection
- Underfloor heating screed dryout
- Water pipe freeze prevention

However, the disinfection function will be activated **ONLY** if the user confirms emergency operation via the user interface.

Compressor forced off

Compressor forced off mode can be activated to only allow the backup heater to provide space heating. When this mode is activated:

- Heat pump operation is NOT possible
- Cooling is NOT possible

#	Code	Description
[9.5.2]	[7-06]	Activation of the Compressor forced off mode: <ul style="list-style-type: none"> ▪ 0: disabled ▪ 1: enabled

Glycol filled system**Glycol Filled system**

This setting gives the installer the possibility to indicate whether the system is filled with glycol or water. This is important in case glycol is used to protect the water circuit against freezing. If NOT set correctly, the liquid in the piping can freeze.

#	Code	Description
N/A	[E-0D]	Glycol Filled system: Is the system filled with glycol? <ul style="list-style-type: none"> ▪ 0: No ▪ 1: Yes

**NOTICE**

If you add glycol to the water, you also need to install a flow switch (EKFLSW2).

Water pipe freeze prevention

Only relevant for installations with water piping outdoors. This function tries to protect outdoor water piping from freezing.

**NOTICE**

If the system does NOT contain a backup heater, then:

- Make sure that the room antifrost control is activated ([2-06]=1).
- Do NOT change the default room antifrost temperature [2-05].
- Make sure that the water pipe freeze prevention is activated ([4-04]≠2).



NOTICE

Water pipe freeze prevention. Even if you turn OFF space heating/cooling operation ([C.2]: Operation > Space heating/cooling), water pipe freeze prevention –if enabled– will remain active.

Benefit kWh power supply

#	Code	Description
[9.8.2]	[D-00]	<p>Restriction: Only applicable if [9.8.4] is NOT set to Smart grid.</p> <p>Allow heater: Which heaters are allowed to operate during preferential kWh rate power supply?</p> <ul style="list-style-type: none"> ▪ 0 No: None ▪ 1 Only BSH: Booster heater only (do NOT use) ▪ 2 Only BUH: Backup heater only ▪ 3 All: All heaters (do NOT use) <p>See also below table (Allowed heaters during preferential kWh rate power supply).</p> <p>Setting 2 is only meaningful if the preferential kWh rate power supply is of type 1 or the hydro module is connected to a separate normal kWh rate power supply (via X2M/5-6) and the backup heater is NOT connected to the preferential kWh rate power supply.</p>
[9.8.3]	[D-05]	<p>Restriction: Only applicable if [9.8.4] is NOT set to Smart grid.</p> <p>Allow pump:</p> <ul style="list-style-type: none"> ▪ 0 No: Pump is forced off ▪ 1 Yes: No limitation

#	Code	Description
[9.8.4]	[D-01]	<p>Connection to a Benefit kWh power supply or a Smart grid:</p> <ul style="list-style-type: none"> ▪ 0 No: The outdoor unit is connected to a normal power supply. ▪ 1 Open: The outdoor unit is connected to a preferential kWh rate power supply. When the preferential kWh rate signal is sent by the electricity company, the contact will open and the unit will go in forced off mode. When the signal is released again, the voltage-free contact will close and the unit will restart operation. Therefore, always enable the auto restart function. ▪ 2 Closed: The outdoor unit is connected to a preferential kWh rate power supply. When the preferential kWh rate signal is sent by the electricity company, the contact will close and the unit will go in forced off mode. When the signal is released again, the voltage-free contact will open and the unit will restart operation. Therefore, always enable the auto restart function. ▪ 3 Smart grid: A Smart Grid is connected to the system
[9.8.5]	N/A	<p>Restriction: Only applicable if [9.8.4]=Smart grid.</p> <p>Shows the Smart Grid operation mode sent by the 2 incoming Smart Grid contacts.</p> <p>Smart grid operation mode:</p> <ul style="list-style-type: none"> ▪ Free running ▪ Forced off ▪ Recommended on ▪ Forced on <p>See also below table (Smart Grid operation modes).</p>
[9.8.6]	N/A	<p>Restriction: Only applicable if [9.8.4]=Smart grid.</p> <p>To set if electrical heaters are allowed.</p> <p>Allow electrical heaters:</p> <ul style="list-style-type: none"> ▪ No ▪ Yes

#	Code	Description
[9.8.7]	N/A	<p>Restriction: Only applicable in case of room thermostat control, and if [9.8.4]=Smart grid.</p> <p>To set if room buffering will be enabled.</p> <p>Enable room buffering:</p> <ul style="list-style-type: none"> ▪ No: The extra energy from the photovoltaic panels is NOT buffered in space heating circuit. ▪ Yes: The extra energy from the photovoltaic panels is buffered in the space heating/cooling circuit (i.e. heat up or cool down the room).
[9.8.8]	N/A	<p>Limit setting kW</p> <p>Restriction: Only applicable if:</p> <ul style="list-style-type: none"> ▪ [9.8.4]=Smart grid. ▪ There is no pulse meter (power meter) for photovoltaic panels available ([9.A.2] Electricity meter 2 = None) <p>Normally, when a pulse meter is available, the following happens:</p> <ul style="list-style-type: none"> ▪ The pulse meter measures the power produced by the photovoltaic panels. ▪ The unit limits its power consumption during the Smart Grid's "Recommended ON" mode to only use the power provided by the photovoltaic panels. <p>However, when the pulse meter is not available, you can still limit the unit's power consumption using this setting (Limit setting kW). This prevents overconsumption and thus requiring the use of power from the grid.</p>

Allowed heaters during preferential kWh rate power supply

Do NOT use 1 or 3. Setting [D-00] to 1 or 3 when [D-01] is set to 1 or 2 will reset [D-00] back to 0, as the system does not have a booster heater. Only set [D-00] to the values in the table below:

[D-00]	Backup heater	Compressor
0	Forced OFF	Forced OFF
2	Allowed	

Smart Grid operation modes

The 2 incoming Smart Grid contacts (see "9.3.12 To connect a Smart Grid" [▶ 98]) can activate the following Smart Grid modes:

Smart Grid contact		[9.8.5] Smart grid operation mode
①	②	
0	0	Free running
0	1	Forced off
1	0	Recommended on
1	1	Forced on

Free running:

The Smart Grid function is NOT active.

Forced off:

- The unit forces OFF the compressor and the backup heater.
- The protective functions (water pipe freeze prevention, drain prevention, room frost protection) and defrost are NOT overruled (capacity will not be limited for these functions)

Recommended on:

- In case the space heating/cooling request is OFF, the unit can choose to buffer energy from the photovoltaic panels in the room (only in case of room thermostat control) instead of putting the photovoltaic panel energy on the grid.

The room will heat up or cool down to the comfort setpoint.

- The goal is to buffer the energy from the photovoltaic panels. Therefore, the capacity of the unit is limited to what the photovoltaic panels are providing:

If Smart Grid pulse meter is...	Then the limit is...
Available	Decided by the unit based on the input of the Smart Grid pulse meter.
Not available	Decided by [9.8.8] Limit setting kW

- The protective functions (water pipe freeze prevention, drain prevention, room frost protection) and defrost are NOT overruled (capacity will not be limited for these functions)

Forced on:

Similar to **Recommended on**, but there is no capacity limitation. The goal is NOT to use the grid as much as possible.

Emergency mode. In case emergency mode is active, buffering with electrical heater is NOT possible in **Forced on** and **Recommended on** operation modes.

Power consumption control**Power consumption control**

See "[6 Application guidelines](#)" [▶ 24] for detailed information about this functionality.

#	Code	Description
[9.9.1]	[4-08]	Power consumption control: <ul style="list-style-type: none"> ▪ 0 No: Disabled. ▪ 1 Continuous: Enabled: You can set one power limitation value (in A or kW) to which the system power consumption will be limited for all the time. ▪ 2 Inputs: Enabled: You can set up to four different power limitation values (in A or kW) to which the system power consumption will be limited when the corresponding digital input asks.

#	Code	Description
[9.9.2]	[4-09]	Type: <ul style="list-style-type: none"> ▪ 0 Amp: The limitation values are set in A. ▪ 1 kW: The limitation values are set in kW.

Limit when [9.9.1]=**Continuous** and [9.9.2]=**Amp**:

#	Code	Description
[9.9.3]	[5-05]	Limit : Only applicable in case of full time current limitation mode. 0 A~50 A

Limits when [9.9.1]=**Inputs** and [9.9.2]=**Amp**:

#	Code	Description
[9.9.4]	[5-05]	Limit 1 : 0 A~50 A
[9.9.5]	[5-06]	Limit 2 : 0 A~50 A
[9.9.6]	[5-07]	Limit 3 : 0 A~50 A
[9.9.7]	[5-08]	Limit 4 : 0 A~50 A

Limit when [9.9.1]=**Continuous** and [9.9.2]=**kW**:

#	Code	Description
[9.9.8]	[5-09]	Limit : Only applicable in case of full time power limitation mode. 0 kW~20 kW

Limits when [9.9.1]=**Inputs** and [9.9.2]=**kW**:

#	Code	Description
[9.9.9]	[5-09]	Limit 1 : 0 kW~20 kW
[9.9.A]	[5-0A]	Limit 2 : 0 kW~20 kW
[9.9.B]	[5-0B]	Limit 3 : 0 kW~20 kW
[9.9.C]	[5-0C]	Limit 4 : 0 kW~20 kW

Priority heater

This setting defines the priority of the electrical heaters depending on applicable limitation. As no booster heater is present, the backup heater will always be prioritised.

#	Code	Description
[9.9.D]	[4-01]	Priority heater: <ul style="list-style-type: none"> ▪ 0 None : The backup heater is prioritised. ▪ 1 Booster heater: After restart, the setting will be reverted back to 0=None and the backup heater will be prioritised. ▪ 2 Backup heater: The backup heater is prioritised.

BBR16

See "[6.5.4 BBR16 power limitation](#)" [▶ 46] for detailed information about this functionality.

**INFORMATION**

Restriction: BBR16 settings are only visible when the language of the user interface is set to Swedish.

**NOTICE**

2 weeks to change. After you activated BBR16, you only have 2 weeks to change its settings (**BBR16 activation** and **BBR16 power limit**). After 2 weeks, the unit freezes these settings.

Note: This is different from the permanent power limitation, which is always changeable.

BBR16 activation

#	Code	Description
[9.9.F]	[7-07]	BBR16 activation: <ul style="list-style-type: none"> ▪ 0: disabled ▪ 1: enabled

BBR16 power limit

#	Code	Description
[9.9.G]	[N/A]	BBR16 power limit: This setting can only be modified via the menu structure. <ul style="list-style-type: none"> ▪ 0 kW~25 kW, step 0.1 kW

Energy metering**Energy metering**

If energy metering is performed by the use of external power meters, configure the settings as described below. Select the pulse frequency output of each power meter in accordance with the power meter specifications. It is possible to connect up to 2 power meters with different pulse frequencies. If only 1 or no power meter is used, select 'None' to indicate the corresponding pulse input is NOT used.

#	Code	Description
[9.A.1]	[D-08]	Electricity meter 1: <ul style="list-style-type: none"> ▪ 0 None: NOT installed ▪ 1 1/10kWh: Installed ▪ 2 1/kWh: Installed ▪ 3 10/kWh: Installed ▪ 4 100/kWh: Installed ▪ 5 1000/kWh: Installed

#	Code	Description
[9.A.2]	[D-09]	<p>Electricity meter 2:</p> <ul style="list-style-type: none"> ▪ 0 None: NOT installed ▪ 1 1/10kWh: Installed ▪ 2 1/kWh: Installed ▪ 3 10/kWh: Installed ▪ 4 100/kWh: Installed ▪ 5 1000/kWh: Installed <p>In case of pulse meter for photovoltaic panels:</p> <ul style="list-style-type: none"> ▪ 6 100/kWh for PV panel: Installed ▪ 7 1000/kWh for PV panel: Installed

Sensors

External sensor

#	Code	Description
[9.B.1]	[C-08]	<p>External sensor: When an optional external ambient sensor is connected, the type of the sensor must be set.</p> <ul style="list-style-type: none"> ▪ 0 None : NOT installed. The thermistor in the user interface and in the outdoor unit are used for measurement. ▪ 1 Outdoor: Connected to the hydro PCB of the outdoor unit measuring the outdoor temperature. Remark: For some functionality, the temperature sensor in the outdoor unit is still used. ▪ 2 Room: Connected to the hydro PCB of the outdoor unit measuring the indoor temperature. The temperature sensor in the user interface is NOT used anymore. Remark: This value has only meaning in room thermostat control.

Ext. amb. sensor offset

ONLY applicable in case an external outdoor ambient sensor is connected and configured.

You can calibrate the external outdoor ambient temperature sensor. It is possible to give an offset to the thermistor value. This setting can be used to compensate for situations where the external outdoor ambient sensor cannot be installed on the ideal installation location.

#	Code	Description
[9.B.2]	[2-0B]	<p>Ext. amb. sensor offset: Offset on the ambient temperature measured on the external outdoor temperature sensor.</p> <ul style="list-style-type: none"> ▪ $-5^{\circ}\text{C} \sim 5^{\circ}\text{C}$, step 0.5°C

Averaging time

The average timer corrects the influence of ambient temperature variations. The weather-dependent setpoint calculation is done on the average outdoor temperature.

The outdoor temperature is averaged over the selected time period.

#	Code	Description
[9.B.3]	[1-0A]	Averaging time: <ul style="list-style-type: none"> ▪ 0: No averaging ▪ 1: 12 hours ▪ 2: 24 hours ▪ 3: 48 hours ▪ 4: 72 hours



INFORMATION

If the power saving function is activated (see [E-08]), the average outdoor temperature calculation is only possible in case the external outdoor temperature sensor is used. See "6.6 Setting up an external temperature sensor" [47].

Bivalent

Bivalent

Only applicable in case of auxiliary boiler.



NOTICE

Bivalent operation is only possible if space heating is turned ON.



INFORMATION

Bivalent is only possible in case of 1 leaving water temperature zone with:

- room thermostat control, OR
- external room thermostat control.

About bivalent

The purpose of this function is to determine which heating source can/will provide the space heating, either the heat pump system or the auxiliary boiler.

#	Code	Description
[9.C.1]	[C-02]	Bivalent: Indicates if the space heating is also performed by means of another heat source than the system. <ul style="list-style-type: none"> ▪ 0 No: Not installed ▪ 1 Yes: Installed. The auxiliary boiler (gas boiler, oil burner) will operate in space heating when the outdoor ambient temperature is low. During bivalent operation, the heat pump will run in domestic hot water operation when tank heat-up is required, or is turned OFF. Set this value in case an auxiliary boiler is used.

- If **Bivalent** is enabled: When the outdoor temperature drops below the bivalent ON temperature (fixed or variable based on energy prices), the space heating by the heat pump stops automatically and the permission signal for the auxiliary boiler is active.
- If **Bivalent** is disabled: Space heating is only done by the heat pump within the operation range. The permission signal for the auxiliary boiler is always inactive.

The switch-over between the heat pump system and the auxiliary boiler is based on the following settings:

- [C-03] and [C-04]
- Electricity price: [7.5.1], [7.5.2], [7.5.3]
- Gas price: [7.6]

[C-03], [C-04], and T_{calc}

Based on the settings above, the heat pump system calculates a value T_{calc} , which is variable between [C-03] and [C-03]+[C-04].

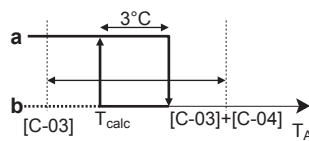

- T_A Outdoor temperature
- T_{calc} Bivalent ON temperature (variable). Below this temperature, the auxiliary boiler will always be ON. T_{calc} can never go below [C-03] or above [C-03]+[C-04].
- 3°C** Fixed hysteresis to prevent too much switching between heat pump system and auxiliary boiler
- a** Auxiliary boiler active
- b** Auxiliary boiler inactive

If the outdoor temperature...	Then...	
	Space heating by the heat pump system...	Bivalent signal for the auxiliary boiler is...
Drops below T_{calc}	Stops	Active
Rises above $T_{calc}+3^{\circ}\text{C}$	Starts	Inactive



INFORMATION

The permission signal for the auxiliary boiler is located on the EKRP1HBAA (digital I/O PCB). When it is activated, the contact X1, X2 is closed and open when it is deactivated. See illustration below for the schematic location of this contact.

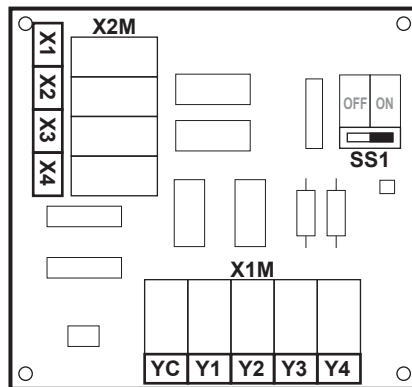

#	Code	Description
9.C.3	[C-03]	Range: $-25^{\circ}\text{C}\sim 25^{\circ}\text{C}$ (step: 1°C)

#	Code	Description
9.C.4	[C-04]	Range: 2°C~10°C (step: 1°C) The higher the value of [C-04], the higher the accuracy of the switch-over between the heat pump system and the auxiliary boiler.

To determine the value of [C-03], proceed as follows:

- 1 Determine the COP (= coefficient of performance) using the formula:

Formula	Example
$\text{COP} = (\text{Electricity price} / \text{gas price})^{(a)} \times \text{boiler efficiency}$	If: <ul style="list-style-type: none"> ▪ Electricity price: 20 c€/kWh ▪ Gas price: 6 c€/kWh ▪ Boiler efficiency: 0.9 Then: $\text{COP} = (20/6) \times 0.9 = 3$

^(a) Make sure to use the same units of measurement for the electricity price and gas price (example: both c€/kWh).

- 2 Determine the value of [C-03] using the graph. For an example, see the table legend.

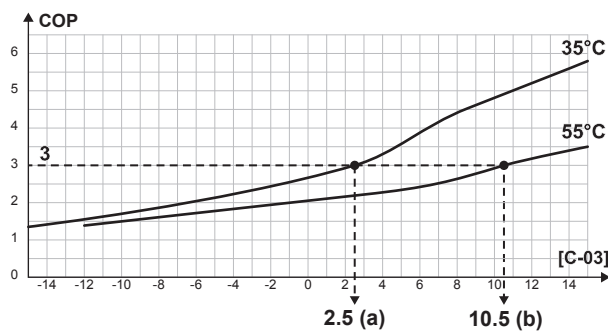

- a [C-03]=2.5 in case of COP=3 and LWT=35°C
- b [C-03]=10.5 in case of COP=3 and LWT=55°C



NOTICE

Make sure to set the value of [5-01] at least 1°C higher than the value of [C-03].

Electricity and gas prices



INFORMATION

To set electricity and gas price values, do NOT use overview settings. Set them in the menu structure instead ([7.5.1], [7.5.2], [7.5.3], and [7.6]). For more information on how to set the energy prices, see the operation manual and the user reference guide.



INFORMATION

Solar panels. If solar panels are used, set the electricity price value very low to promote the use of the heat pump.

#	Code	Description
[7.5.1]	N/A	User settings > Electricity price > High

#	Code	Description
[7.5.2]	N/A	User settings > Electricity price > Medium
[7.5.3]	N/A	User settings > Electricity price > Low
[7.6]	N/A	User settings > Gas price

Boiler efficiency

Depending on the used boiler, this should be chosen as follows:

#	Code	Description
[9.C.2]	[7-05]	<ul style="list-style-type: none"> ▪ 0: Very high ▪ 1: High ▪ 2: Medium ▪ 3: Low ▪ 4: Very low

Alarm output

Alarm output

#	Code	Description
[9.D]	[C-09]	<p>Alarm output: Indicates the logic of alarm output on digital I/O PCB during high level indoor unit error malfunctioning. Low level errors (caution/warning) will NOT be transmitted to alarm output.</p> <ul style="list-style-type: none"> ▪ 0 Abnormal: The alarm output will be powered when an alarm occurs. By setting this value, a distinction is made between the detection of an alarm, and the detection of a power failure. ▪ 1 Normal: The alarm output will NOT be powered when an alarm occurs. <p>See also table below (Alarm output logic).</p>

Alarm output logic

[C-09]	Alarm	No alarm	No power supply to unit
0	Closed output	Open output	Open output
1	Open output	Closed output	

Auto restart

Auto restart

When power returns after a power supply failure, the auto restart function reapplies the user interface settings at the time of the power failure. Therefore, it is recommended to always enable the function.

If the preferential kWh rate power supply is of the type that power supply is interrupted, always enable the auto restart function. Continuous hydro module control can be guaranteed independent of the preferential kWh rate power supply status, by connecting the hydro module to a separate normal kWh rate power supply.

#	Code	Description
[9.E]	[3-00]	Auto restart: <ul style="list-style-type: none"> ▪ 0: Manual ▪ 1: Automatic

Disable protections



INFORMATION

Protective functions – "Installer-on-site mode". The software is equipped with protective functions, such as room antifrost. The unit automatically runs these functions when necessary.

During installation or service this behaviour is undesired. Therefore, the protective functions can be disabled:

- **At first power-on:** The protective functions are disabled by default. After 12 hours they will be automatically enabled.
- **Afterwards:** An installer can manually disable the protective functions by setting [9.G]: **Disable protections=Yes**. After his work is done, he can enable the protective functions by setting [9.G]: **Disable protections=No**.

#	Code	Description
[9.G]	N/A	Disable protections: <ul style="list-style-type: none"> ▪ 0: No ▪ 1: Yes

Power saving function

Power saving function

Defines whether the power supply to the compressor module can be interrupted (internally by hydro module control) during stand-still conditions (no space heating/cooling). The final decision to allow power interruption of the compressor module during standstill depends on the ambient temperature, compressor conditions and minimum internal timers.

To enable the power saving function setting, [E-08] needs to be enabled on the user interface.

#	Code	Description
[9.F]	[E-08]	Power saving function for compressor module: <ul style="list-style-type: none"> ▪ 0: No ▪ 1: Yes

Forced defrost

Forced defrost

Manually start a defrost operation. The forced defrost will only start when at least the following conditions are fulfilled:

- Unit is in heating operation and has been running for a few minutes
- Outdoor ambient temperature is low enough
- Temperature at the outdoor unit heat exchanger coil is low enough

#	Code	Description
[9.H]	N/A	Do you want to start a defrost operation? <ul style="list-style-type: none"> ▪ Back ▪ OK



NOTICE
Forced defrost start-up. You can only start forced defrost when the heating operation has been running for a while.

Overview field settings



Almost all settings can be done using the menu structure. If for any reason it is required to change a setting using the overview settings, then the overview settings can be accessed in the field settings overview [9.1]. See ["To modify an overview setting" \[▶ 105\]](#).

Export MMI settings

About exporting the configuration settings

#	Code	Description
[9.N]	N/A	Your MMI settings will be exported to the connected storage device: <ul style="list-style-type: none"> ▪ Back ▪ OK

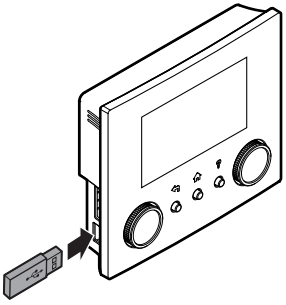
To export MMI settings

1	Insert a USB memory stick in the user interface. 	—
2	On the user interface, go to [9.N] Export MMI settings.	
3	Select OK.	
4	Remove the USB memory stick.	—

Bizone kit

Additionally to the settings listed below, make sure to also set [7-02]=1 (i.e. [4.4] **Number of zones = Dual zone**) when a bizone kit is installed.

See also ["6.2.3 Multiple rooms – Two LWT zones" \[▶ 33\]](#) and ["Number of zones" \[▶ 150\]](#).

Bizone kit installed

#	Code	Description
[9.P.1]	[E-OB]	Bizone kit installed: <ul style="list-style-type: none"> 0 No : The system only has a main zone. 1 N/A 2 Yes: A bizone kit is installed in order to add an additional temperature zone.

Bizone kit system type

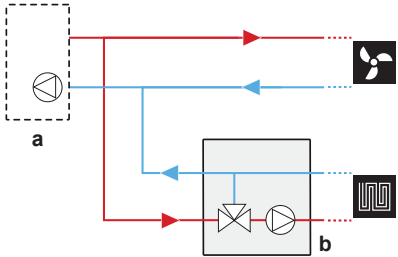
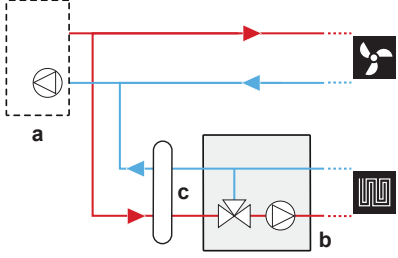
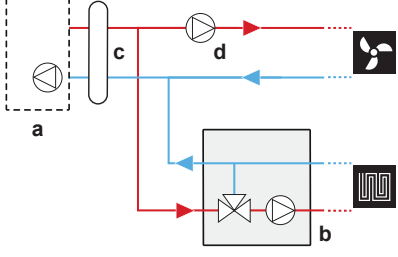
#	Code	Description
[9.P.2]	[E-OC]	Bizone system type <ul style="list-style-type: none"> 0 Without hydraulic separator / no direct pump  <ul style="list-style-type: none"> 1 With hydraulic separator / no direct pump  <ul style="list-style-type: none"> 2 With hydraulic separator / with direct pump  <p>a: Indoor unit; b: Mixing station; c: Hydraulic separator; d: Direct pump</p>

Additional zone pump fixed PWM

The speed of the additional zone pump can be fixed with this setting.

#	Code	Description
[9.P.3]	[7-0A]	Add zone pump fixed PWM: Fixed pump speed for additional (direct) zone. <ul style="list-style-type: none"> 20~95% (default: 95)

Main zone pump fixed PWM

The speed of the main zone pump can be fixed with this setting.

#	Code	Description
[9.P.4]	[7-0B]	Main zone pump fixed PWM: Fixed pump speed for main (mixed) zone. <ul style="list-style-type: none"> ▪ 20~95% (default: 95)

Mixing valve turning time

If a third party mixing valve is installed in combination with controller EKMIKPOA, the valve turning time must be set accordingly.

For this setting, space heating/cooling and tank operation MUST be off: [C.2] Space heating/cooling=0 (Off) and [C.3] Tank=0 (Off). See "10.6.11 Operation" [▶ 181].

#	Code	Description
[9.P.5]	[7-0C]	Mixing valve turning time: Time in seconds for the mixing valve to turn from one side to the other. <ul style="list-style-type: none"> ▪ 20~300 sec (default: 125)

In case a bizon kit is installed, antiblockage of kit pump(s) and kit mixing valve

#	Code	Description
[9.I]	[3-0D]	In case a bizon kit is installed, antiblockage of kit pump(s) and kit mixing valve <ul style="list-style-type: none"> ▪ 0: disabled ▪ 1: enabled



NOTICE

The unit reboots as soon as a bizon kit is connected. After reboot of the unit we recommend to set [3-0D]=1.

10.6.9 Commissioning

Overview

The following items are listed in the submenu:

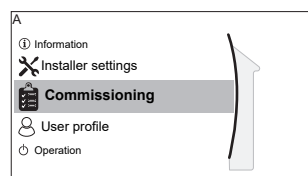

[A] Commissioning

- [A.1] Operation test run
- [A.2] Actuator test run
- [A.3] Air purge
- [A.4] UFH screed dryout
- [A.5] Pump down

About commissioning

See: "11 Commissioning" [▶ 186]

10.6.10 User profile

[B] User profile: See "To change the user permission level" [▶ 104].

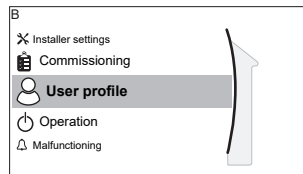

[B] User profile

10.6.11 Operation

Overview

The following items are listed in the submenu:

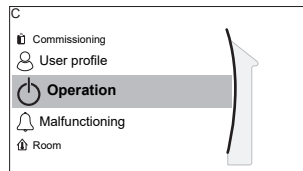

[C] Operation

[C.2] Space heating/cooling

To enable or disable functionalities

In the operation menu, you can separately enable or disable functionalities of the unit.

#	Code	Description
[C.2]	N/A	Space heating/cooling: <ul style="list-style-type: none"> ▪ 0: Off ▪ 1: On

10.6.12 WLAN



INFORMATION

Restriction: WLAN settings are only visible when a WLAN cartridge is inserted in the user interface.

Overview

The following items are listed in the submenu:

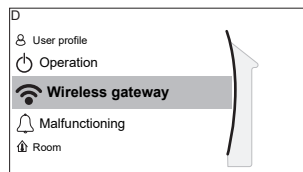

[D] Wireless gateway

[D.1] Mode

[D.2] Reboot

[D.3] WPS

[D.4] Remove from cloud

[D.5] Home network connection



[D.6] Cloud connection

About the WLAN cartridge

The WLAN cartridge connects the system to the internet. The user can then control the system via the ONECTA app.

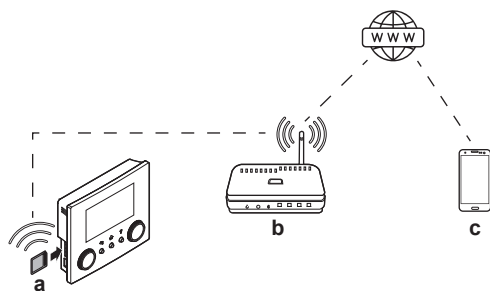
This needs the following components:



a	WLAN cartridge	The WLAN cartridge needs to be inserted in the user interface. See the installation manual of the WLAN cartridge.
b	Router	Field supply.
c	Smartphone + app 	The ONECTA app needs to be installed on the user's smartphone. See: http://www.onlinecontroller.daikineurope.com/ 

Configuration

To configure the ONECTA app, follow the in-app instructions. While doing this, the following actions and information are needed on the user interface:

Mode: Turn AP mode ON (= WLAN adapter active as access point) or OFF.

#	Code	Description
[D.1]	N/A	Enable AP mode: <ul style="list-style-type: none"> ▪ No ▪ Yes

Reboot: Reboot the WLAN cartridge.

#	Code	Description
[D.2]	N/A	Reboot the gateway: <ul style="list-style-type: none"> ▪ Back ▪ OK

WPS: Connect the WLAN cartridge to the router.

#	Code	Description
[D.3]	N/A	WPS: <ul style="list-style-type: none"> ▪ No ▪ Yes

 **INFORMATION**
 You can only use this function if it is supported by the software version of the WLAN, and the software version of the ONECTA app.

Remove from cloud: Remove the WLAN cartridge from the cloud.

#	Code	Description
[D.4]	N/A	Remove from cloud: <ul style="list-style-type: none"> ▪ No ▪ Yes

Home network connection: Read out the status of the connection to the home network.

#	Code	Description
[D.5]	N/A	Home network connection: <ul style="list-style-type: none"> ▪ Disconnected from [WLAN_SSID] ▪ Connected to [WLAN_SSID]

Cloud connection: Read out the status of the connection to the cloud.

#	Code	Description
[D.6]	N/A	Cloud connection: <ul style="list-style-type: none"> ▪ Not connected ▪ Connected

10.7 Menu structure: Overview user settings

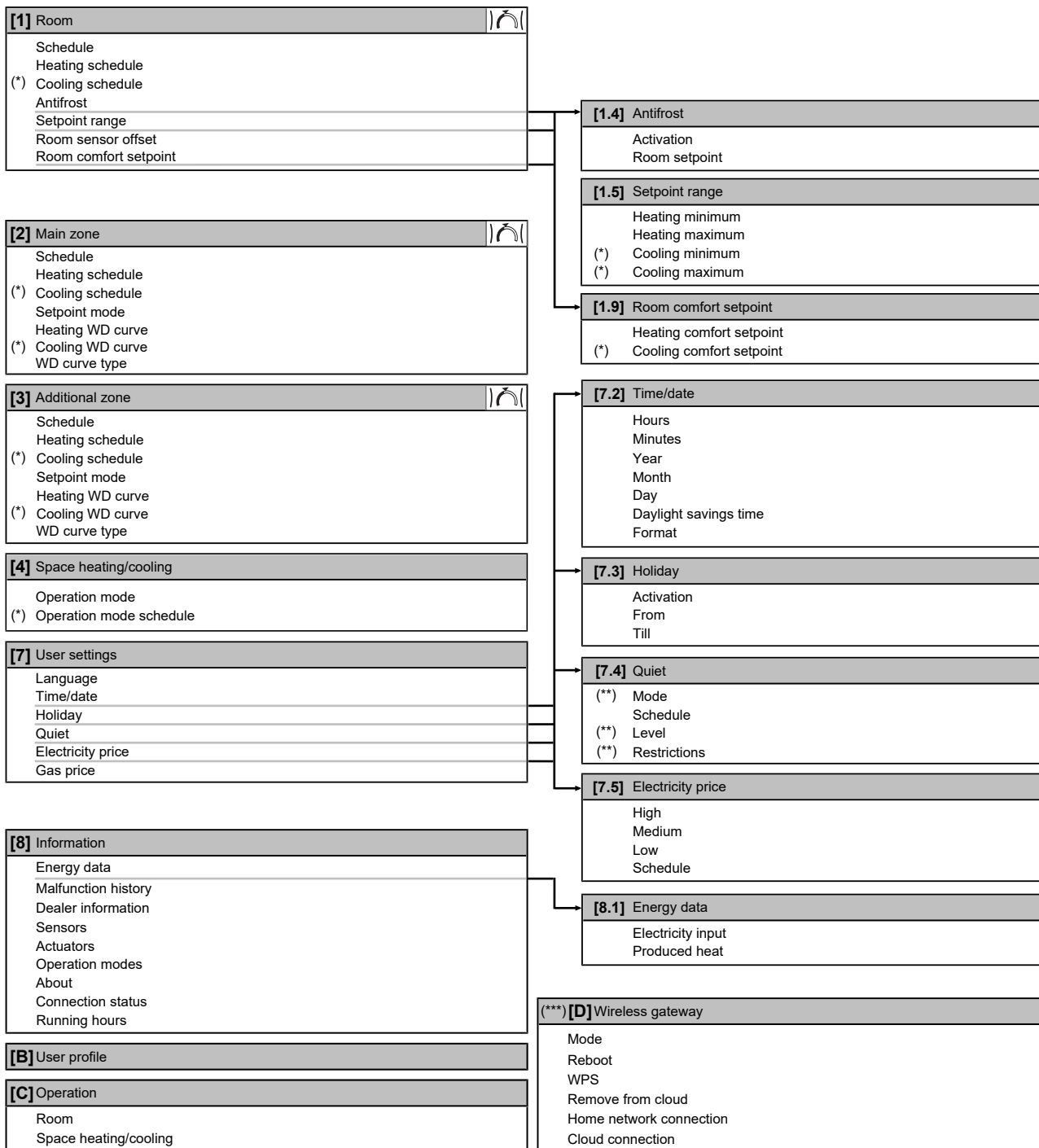

- Setpoint screen
- (*) Only applicable for models where cooling is possible
- (**) Only accessible by installer
- (***) Only applicable when WLAN is installed



INFORMATION

Depending on the selected installer settings and unit type, settings will be visible/invisible.

10.8 Menu structure: Overview installer settings

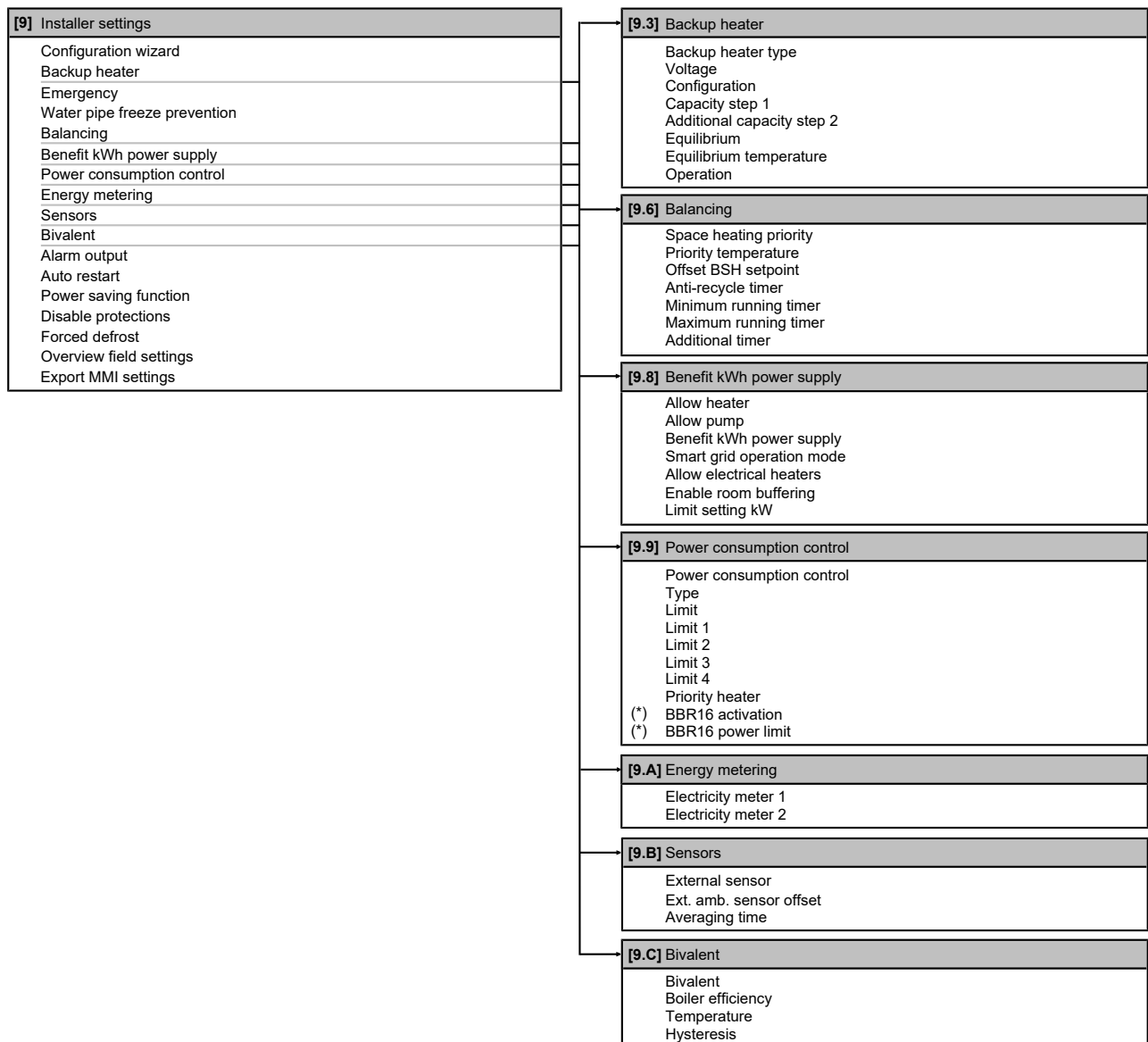

(*) Only applicable in Swedish language.



INFORMATION

Depending on the selected installer settings and unit type, settings will be visible/invisible.

11 Commissioning



NOTICE

General commissioning checklist. Next to the commissioning instructions in this chapter, a general commissioning checklist is also available on the Daikin Business Portal (authentication required).

The general commissioning checklist is complementary to the instructions in this chapter and can be used as a guideline and reporting template during commissioning and hand-over to the user.



NOTICE

The unit contains an automatic air purge valve. Make sure it is open. All automatic air purge valves in the system (in the unit, and in the field piping – if any) must remain open after commissioning.



INFORMATION

Protective functions – "Installer-on-site mode". The software is equipped with protective functions, such as room antifrost. The unit automatically runs these functions when necessary.

During installation or service this behaviour is undesired. Therefore, the protective functions can be disabled:

- **At first power-on:** The protective functions are disabled by default. After 12 hours they will be automatically enabled.
- **Afterwards:** An installer can manually disable the protective functions by setting [9.G]: **Disable protections=Yes**. After his work is done, he can enable the protective functions by setting [9.G]: **Disable protections=No**.

In this chapter

11.1	Overview: Commissioning.....	186
11.2	Precautions when commissioning.....	187
11.3	Checklist before commissioning.....	187
11.4	Checklist during commissioning.....	188
11.4.1	Minimum flow rate	188
11.4.2	Air purge function	189
11.4.3	Operation test run.....	191
11.4.4	Actuator test run	191
11.4.5	Underfloor heating screed dryout	192

11.1 Overview: Commissioning

This chapter describes what you have to do and know to commission the system after it is installed and configured.

Typical workflow

Commissioning typically consists of the following stages:

- 1 Checking the "Checklist before commissioning".
- 2 Performing an air purge.
- 3 Performing a test run for the system.
- 4 If necessary, performing a test run for one or more actuators.
- 5 If necessary, performing an underfloor heating screed dryout.

11.2 Precautions when commissioning



INFORMATION

During the first running period of the unit, the required power may be higher than stated on the nameplate of the unit. This phenomenon is caused by the compressor, that needs a continuous run time of 50 hours before reaching smooth operation and stable power consumption.



NOTICE

Before starting up the system, the unit **MUST** be energised for at least 6 hours. At negative ambient temperatures, the compressor oil needs to be heated to avoid oil shortage and compressor breakdown during startup.



NOTICE

ALWAYS operate the unit with thermistors and/or pressure sensors/switches. If **NOT**, burning of the compressor might be the result.

11.3 Checklist before commissioning

- 1 After the installation of the unit, check the items listed below.
- 2 Close the unit.
- 3 Power up the unit.

<input type="checkbox"/>	You read the complete installation instructions, as described in the installer reference guide .
<input type="checkbox"/>	The outdoor unit is properly mounted.
<input type="checkbox"/>	The switchbox is rotated back and correctly engaged in the switchbox holder.
<input type="checkbox"/>	Field wiring Check that the field wiring has been carried out according to the instructions described in the chapter " 9 Electrical installation " [▶ 72], according to the wiring diagrams and according to the applicable national wiring regulation.
<input type="checkbox"/>	The system is properly earthed and the earth terminals are tightened.
<input type="checkbox"/>	The fuses or locally installed protection devices are installed according to this document, and have NOT been bypassed.
<input type="checkbox"/>	The power supply voltage matches the voltage on the identification label of the unit.
<input type="checkbox"/>	There are NO loose connections or damaged electrical components in the switch box.
<input type="checkbox"/>	There are NO damaged components or squeezed pipes on the inside of the outdoor unit.

<input type="checkbox"/>	Only for models with integrated backup heater (F1B: field supply), or if the external backup heater kit (F1B: factory-mounted in the backup heater kit) is installed: Backup heater circuit breaker F1B is turned ON.
<input type="checkbox"/>	The correct pipe size is installed and the pipes are properly insulated.
<input type="checkbox"/>	There are no water leaks inside the outdoor unit.
<input type="checkbox"/>	The shut-off valves are properly installed and fully open.
<input type="checkbox"/>	The automatic air purge valve is open.
<input type="checkbox"/>	The pressure relief valve (space heating circuit) purges water when opened. Clean water MUST come out.
<input type="checkbox"/>	The minimum water volume is guaranteed in all conditions. See "To check the water volume and flow rate" in " 8.1 Preparing water piping " [▶ 59].

11.4 Checklist during commissioning

<input type="checkbox"/>	The minimum flow rate is guaranteed in all conditions. See "To check the water volume and flow rate" in " 8.1 Preparing water piping " [▶ 59].
<input type="checkbox"/>	To perform an air purge .
<input type="checkbox"/>	To perform a test run .
<input type="checkbox"/>	To perform an actuator test run .
<input type="checkbox"/>	Underfloor screed dryout function The underfloor screed dryout function is started (if necessary).

11.4.1 Minimum flow rate

Purpose

For a correct operating unit, it is important to check if the minimum flow rate is reached. If needed, modify the bypass valve setting.

If operation is...	Then the minimum required flow rate is...
Cooling	10 l/min
Heating	6 l/min
BUH operation	12 l/min
Heating defrost	12 l/min

To check the minimum flow rate

1	Check the hydraulic configuration to find out which space heating loops can be closed by mechanical, electronic, or other valves.	—
2	Close all space heating loops that can be closed.	—
3	Start the pump test run (see " 11.4.4 Actuator test run " [▶ 191]).	—
4	Read out the flow rate ^(a) and modify the bypass valve setting to reach the minimum required flow rate + 2 l/min.	—

^(a) During pump test run, the unit can operate below the minimum required flow rate.

11.4.2 Air purge function

Purpose

When commissioning and installing the unit, it is very important to remove all air in the water circuit. When the air purge function is running, the pump operates without actual operation of the unit and the removal of air in the water circuit will start.



NOTICE

Before starting the air purge, open the safety valve and check if the circuit is sufficiently filled with water. Only if water escapes the valve after opening it, you can start the air purge procedure.

Manual or automatic

There are 2 modes for purging air:

- Manual: You can set the pump speed to low or high. You can set the circuit (the position of the 3-way valve) to Space or Tank. Air purge must be performed for both space heating and tank (domestic hot water) circuits.
- Automatic: The unit automatically changes the pump speed and switches the position of the 3-way valve between the space heating and the domestic hot water circuit.

Typical workflow

Purging the air from the system should consist of:

- 1 Performing a manual air purge
- 2 Performing an automatic air purge



NOTICE

When purging air with the manual air purge valve of the unit, collect any fluid that might leak out of the valve. If this fluid is NOT collected, it might drip on internal components and damage the unit.



INFORMATION

- To purge air, use all air purge valves present in the system. This includes the automatic or manual air purge valve of the outdoor unit, as well as any field-supplied valves.
- If the system contains an external backup heater kit, also use the air purge valve of the backup heater.
- If the system contains valve kit EKMBHBP1, it is required to – during the air purge – manually switch the position of the valve kit's 3-way valve by turning its knob, this to prevent air from remaining in the bypass. For more information, see "[9.3.3 External backup heater kit](#)" ▶ 83].



INFORMATION

Start by performing a manual air purge. When almost all the air is removed, perform an automatic air purge. If necessary, repeat performing the automatic air purge until you are sure that all air is removed from the system. During air purge function, pump speed limitation [9-0D] is NOT applicable.

The air purge function automatically stops after 30 minutes.

**INFORMATION**

For best results, air purge each loop separately.

To perform a manual air purge**Conditions:** Make sure all operation is disabled. Go to [C]: **Operation** and turn off **Space heating/cooling** operation.

1	Set the user permission level to Installer . See " To change the user permission level " [▶ 104].	—
2	Go to [A.3]: Commissioning > Air purge .	
3	In the menu, set Type = Manual .	
4	Select Start air purge .	
5	Select OK to confirm. Result: The air purge starts. It stops automatically when ready.	
6	During manual operation: <ul style="list-style-type: none"> You can change the pump speed. You must change the circuit. To change these settings during the air purge, open the menu and go to [A.3.1.5]: Settings .	
	<ul style="list-style-type: none"> Scroll to Circuit and set it to Space/Tank. 	
	<ul style="list-style-type: none"> Scroll to Pump speed and set it to Low/High. 	
7	To stop the air purge manually:	—
1	Open the menu and go to Stop air purge .	
2	Select OK to confirm.	

To perform an automatic air purge**Conditions:** Make sure all operation is disabled. Go to [C]: **Operation** and turn off **Space heating/cooling** operation.

1	Set the user permission level to Installer . See " To change the user permission level " [▶ 104].	—
2	Go to [A.3]: Commissioning > Air purge .	
3	In the menu, set Type = Automatic .	
4	Select Start air purge .	
5	Select OK to confirm. Result: The air purge starts. It stops automatically when done.	
6	To stop the air purge manually:	—
1	In the menu, go to Stop air purge .	
2	Select OK to confirm.	

11.4.3 Operation test run





Purpose

Perform test runs on the unit and monitor the leaving water temperature to check if the unit is working correctly. The following test runs should be made:

- Heating (if applicable)
- Cooling

To perform an operation test run

Conditions: Make sure all operation is disabled. Go to [C]: **Operation** and turn off **Space heating/cooling** operation.

1	Set the user permission level to Installer . See " To change the user permission level " [▶ 104].	—
2	Go to [A.1]: Commissioning > Operation test run .	
3	Select a test from the list. Example: Heating .	
4	Select OK to confirm. Result: The test run starts. It stops automatically when ready (±30 min). To stop the test run manually:	
1	In the menu, go to Stop test run .	
2	Select OK to confirm.	



**INFORMATION**

If the outdoor temperature is outside the range of operation, the unit may NOT operate or may NOT deliver the required capacity.

To monitor leaving water temperature

During test run, the correct operation of the unit can be checked by monitoring its leaving water temperature (heating/cooling mode).

To monitor the temperature:

1	In the menu, go to Sensors .	
2	Select the temperature information.	



11.4.4 Actuator test run



Purpose

Perform an actuator test run to confirm the operation of the different actuators. For example, when you select **Pump**, a test run of the pump will start.

To perform an actuator test run

Conditions: Make sure all operation is disabled. Go to [C]: **Operation** and turn off **Space heating/cooling** operation.

1	Set the user permission level to Installer . See " To change the user permission level " [▶ 104].	—
2	Go to [A.2]: Commissioning > Actuator test run .	
3	Select a test from the list. Example: Pump .	

4	Select OK to confirm. Result: The actuator test run starts. It stops automatically when ready (± 30 min).	
	To stop the test run manually:	—
1	In the menu, go to Stop test run .	
2	Select OK to confirm.	

Possible actuator test runs

- Backup heater 1 test
- Backup heater 2 test
- Pump test



INFORMATION

Make sure that all air is purged before executing the test run. Also avoid disturbances in the water circuit during the test run.

- Bivalent signal test
- Alarm output test
- C/H signal test
- Bizone kit direct pump test (bizone kit EKMIKPOA or EKMIKPHA)
- Bizone kit mixed pump test (bizone kit EKMIKPOA or EKMIKPHA)
- Bizone kit mixing valve test (bizone kit EKMIKPOA or EKMIKPHA)

11.4.5 Underfloor heating screed dryout

About underfloor heating screed dryout

Purpose

The underfloor heating (UFH) screed dryout function is used for drying out the screed of an underfloor heating system during the construction of the building.



NOTICE

The installer is responsible for:

- contacting the screed manufacturer for the maximum allowed water temperature, to avoid cracking the screed,
- programming the underfloor heating screed dryout schedule according to the initial heating instructions of the screed manufacturer,
- checking the proper functioning of the setup on a regular basis,
- performing the correct program complying with the type of the used screed.

UFH screed dryout after installation of outdoor unit

If the outdoor ambient temperature and [4-02] setting $> 25^{\circ}\text{C}$ the backup heater will perform the screed dryout and supply the leaving water without heat pump operation.

To program an underfloor heating screed dryout schedule

Duration and temperature

The installer can program up to 20 steps. For each step he needs to enter:

- 1 the duration in hours, up to 72 hours,
- 2 the desired leaving water temperature, up to 55°C.

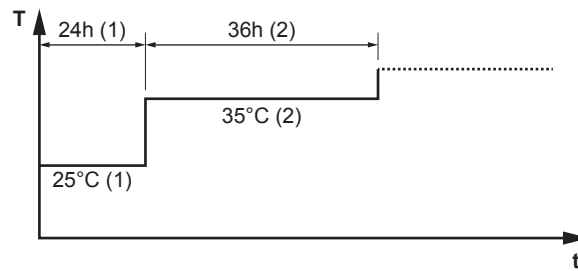
Example:

- T** Desired leaving water temperature (15~55°C)
t Duration (1~72 h)
(1) Action step 1
(2) Action step 2

Steps

1	Set the user permission level to Installer . See " To change the user permission level " [▶ 104].	—
2	Go to [A.4.2]: Commissioning > UFH screed dryout > Program .	
3	Program the schedule: To add a new step, select the next empty line and change its value. To delete a step and all steps below it, decrease the duration to "—".	—
	<ul style="list-style-type: none"> ▪ Scroll through the schedule. 	
	<ul style="list-style-type: none"> ▪ Adjust the duration (between 1 and 72 hours) and temperatures (between 15°C and 55°C). 	
4	Press the left dial to save the schedule.	

To perform an underfloor heating screed dryout**INFORMATION**

- If **Emergency** is set to **Manual** ([9.5]=0), and the unit is triggered to start emergency operation, the user interface will ask confirmation before starting. The underfloor heating screed dryout function is active even if the user does NOT confirm emergency operation.
- During underfloor heating screed dryout, pump speed limitation [9-0D] is NOT applicable.

**NOTICE**

To perform an underfloor heating screed dryout, room frost protection needs to be disabled ([2-06]=0). By default, it is enabled ([2-06]=1). However, due to the "installer-on-site" mode (see "Commissioning"), room frost protection will be automatically disabled for 12 hours after the first power-on.

If the screed dryout still needs to be performed after the first 12 hours of power-on, manually disable room frost protection by setting [2-06] to "0", and KEEP it disabled until the screed dryout has finished. Ignoring this notice will result in cracking of the screed.

**NOTICE**

For the underfloor heating screed dryout to be able to start, make sure the following settings are met:

- [4-00]=1
- [C-02]=0
- [D-01]=0
- [4-08]=0
- [4-01]≠1

Steps

Conditions: An underfloor heating screed dryout schedule has been programmed. See "[To program an underfloor heating screed dryout schedule](#)" [▶ 192].

Conditions: Make sure all operation is disabled. Go to [C]: **Operation** and turn off **Space heating/cooling** operation.

1	Set the user permission level to Installer . See " To change the user permission level " [▶ 104].	—
2	Go to [A.4]: Commissioning > UFH screed dryout .	
3	Select Start UFH screed dryout .	
4	Select OK to confirm. Result: The underfloor heating screed dryout starts. It stops automatically when done.	
5	To stop the underfloor heating screed dryout manually:	—
1	Open the menu and go to Stop UFH screed dryout .	
2	Select OK to confirm.	

To read out the status of an underfloor heating screed dryout

Conditions: You are performing an underfloor heating screed dryout.

1	Press the back button. Result: A graph is displayed, highlighting the current step of the screed dryout schedule, the total remaining time, and the current desired leaving water temperature.	
2	Press the left dial to open the menu structure and to:	
1	View the status of sensors and actuators.	—
2	Adjust the current program	—



To stop an underfloor heating (UFH) screed dryout**U3-error**

When the program is stopped by an error or an operation switch off, the U3 error will be displayed on the user interface. To resolve the error codes, see "[14.4 Solving problems based on error codes](#)" [▶ 204].

In case of a power failure, the U3 error is not generated. When power is restored, the unit automatically restarts the latest step and continues the program.

Stop UFH screed dryout

To manually stop underfloor heating screed dryout:

1	Go to [A.4.3]: Commissioning > UFH screed dryout	—
2	Select Stop UFH screed dryout .	
3	Select OK to confirm. Result: The underfloor heating screed dryout is stopped.	

Read out UFH screed dryout status

When the program is stopped due to an error, an operation switch-off, or a power failure, you can read out the underfloor heating screed dryout status:

1	Go to [A.4.3]: Commissioning > UFH screed dryout > Status	
2	You can read out the value here: Stopped at + the step where the underfloor screed dryout was stopped.	—
3	Modify and restart the execution of the program ^(a) .	—

^(a) If the UFH screed dryout program was stopped due to a power failure and the power resumes, the program will automatically restart the last implemented step.

12 Hand-over to the user

Once the test run is finished and the unit operates properly, make sure the following is clear for the user:

- Fill in the installer setting table (in the operation manual) with the actual settings.
- Make sure that the user has the printed documentation and ask him/her to keep it for future reference. Inform the user that he can find the complete documentation at the URL mentioned earlier in this manual.
- Explain the user how to properly operate the system and what to do in case of problems.
- Show the user what to do for the maintenance of the unit.
- Explain about energy saving tips to the user as described in the operation manual.

13 Maintenance and service



NOTICE

General maintenance/inspection checklist. Next to the maintenance instructions in this chapter, a general maintenance/inspection checklist is also available on the Daikin Business Portal (authentication required).

The general maintenance/inspection checklist is complementary to the instructions in this chapter and can be used as a guideline and reporting template during maintenance.



NOTICE

Maintenance **MUST** be done by an authorised installer or service agent.

We recommend performing maintenance at least once a year. However, applicable legislation might require shorter maintenance intervals.

In this chapter

13.1	Maintenance safety precautions.....	197
13.2	Yearly maintenance	197
13.2.1	Yearly maintenance outdoor unit: overview	197
13.2.2	Yearly maintenance outdoor unit: instructions.....	198

13.1 Maintenance safety precautions



DANGER: RISK OF ELECTROCUTION



DANGER: RISK OF BURNING/SCALDING



NOTICE: Risk of electrostatic discharge

Before performing any maintenance or service work, touch a metal part of the unit in order to eliminate static electricity and to protect the PCB.

13.2 Yearly maintenance

13.2.1 Yearly maintenance outdoor unit: overview

Check the following at least once a year:

- Heat exchanger
- Water filter
- Water pressure
- Water pressure relief valve
- Switch box

13.2.2 Yearly maintenance outdoor unit: instructions

Heat exchanger

The heat exchanger of the outdoor unit can get blocked up due to dust, dirt, leaves, etc. It is recommended to clean the heat exchanger yearly. A blocked heat exchanger can lead to too low pressure or too high pressure leading to worse performance.

Water filter

Close the valve. Clean and rinse the water filter.

**NOTICE**

Handle the filter with care. To prevent damage to the mesh of the filter, do NOT use excessive force when you reinsert it.

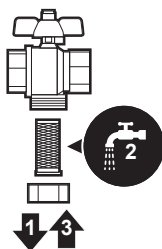
**Water pressure**

Keep water pressure above 1 bar. If it is lower, add water.

Water pressure relief valve

Open the valve and check if it operates correctly. **The water may be very hot!**

Checkpoints are:

- The water flow coming from the relief valve is high enough, no blockage of the valve or in between piping is suspected.
- Dirty water coming out of the relief valve:
 - open the valve until the discharged water does NOT contain dirt anymore
 - flush the system

It is recommended to do this maintenance more frequently.

Switch box

- Carry out a thorough visual inspection of the switch box and look for obvious defects such as loose connections or defective wiring.
- Using an ohmmeter, check if contactors K1M, K2M, K3M and K5M (depending on your installation) operate correctly. All contacts of these contactors must be in open position when the power is turned OFF.

**WARNING**

If the internal wiring is damaged, it has to be replaced by the manufacturer, its service agent or similarly qualified persons.

14 Troubleshooting

In this chapter

14.1	Overview: Troubleshooting	199
14.2	Precautions when troubleshooting	199
14.3	Solving problems based on symptoms	200
14.3.1	Symptom: The unit is NOT heating or cooling as expected	200
14.3.2	Symptom: Hot water does NOT reach the desired temperature	200
14.3.3	Symptom: The compressor does NOT start	201
14.3.4	Symptom: The system is making gurgling noises after commissioning	201
14.3.5	Symptom: The pump is blocked	202
14.3.6	Symptom: The pump is making noise (cavitation)	203
14.3.7	Symptom: The pressure relief valve opens	203
14.3.8	Symptom: The water pressure relief valve leaks	203
14.3.9	Symptom: The space is NOT sufficiently heated at low outdoor temperatures	204
14.3.10	Symptom: The pressure at the tapping point is temporarily unusually high	204
14.4	Solving problems based on error codes	204
14.4.1	To display the help text in case of a malfunction	205
14.4.2	Error codes of the unit	205

14.1 Overview: Troubleshooting

This chapter describes what you have to do in case of problems.

It contains information about:

- Solving problems based on symptoms
- Solving problems based on error codes

Before troubleshooting

Carry out a thorough visual inspection of the unit and look for obvious defects such as loose connections or defective wiring.

14.2 Precautions when troubleshooting



DANGER: RISK OF ELECTROCUTION



DANGER: RISK OF BURNING/SCALDING



WARNING

- When carrying out an inspection on the switch box of the unit, ALWAYS make sure that the unit is disconnected from the mains. Turn off the respective circuit breaker.
- When a safety device was activated, stop the unit and find out why the safety device was activated before resetting it. NEVER shunt safety devices or change their values to a value other than the factory default setting. If you are unable to find the cause of the problem, call your dealer.

**WARNING**

Prevent hazards due to inadvertent resetting of the thermal cut-out: power to this appliance **MUST NOT** be supplied through an external switching device, such as a timer, or connected to a circuit that is regularly turned ON and OFF by the utility.

14.3 Solving problems based on symptoms

14.3.1 Symptom: The unit is NOT heating or cooling as expected

Possible causes	Corrective action
The temperature setting is NOT correct	Check the temperature setting on the remote controller. Refer to the operation manual.
The water flow is too low	<p>Check and make sure that:</p> <ul style="list-style-type: none"> ▪ All shut-off valves of the water circuit are completely open. ▪ The water filter is clean. Clean if necessary. ▪ There is no air in the system. Purge air if necessary. You can purge air manually (see "To perform a manual air purge" [▶ 190]) or use the automatic air purge function (see "To perform an automatic air purge" [▶ 190]). ▪ The water pressure is >1 bar. ▪ The expansion vessel is NOT broken. ▪ The resistance in the water circuit is NOT too high for the pump (see the ESP curve). <p>If the problem persists after you have conducted all of the above checks, contact your dealer. In some cases, it is normal that the unit decides to use a low water flow.</p>
The water volume in the installation is too low	Make sure that the water volume in the installation is above the minimum required value (see " 8.1.3 To check the water volume and flow rate " [▶ 61]).

14.3.2 Symptom: Hot water does NOT reach the desired temperature



Possible causes	Corrective action
One of the tank temperature sensors is broken.	See the service manual of the unit for the corresponding corrective action.

14.3.3 Symptom: The compressor does NOT start

Possible causes	Corrective action
The unit must start up out of its operation range (the water temperature is too low)	<p>If the system contains a backup heater:</p> <p>If the water temperature is too low, the unit uses the backup heater to reach the minimum water temperature first (15°C).</p> <p>Check and make sure that:</p> <ul style="list-style-type: none"> ▪ The power supply to the backup heater is correctly wired. ▪ The backup heater thermal protector is NOT activated. ▪ The backup heater contactors are NOT broken. <p>If the system does NOT contain a backup heater:</p> <p>It may be required to start up with a small water volume. To do this, gradually open the heat emitters. As a result, the water temperature will gradually rise. Monitor the inlet water temperature and make sure it does NOT drop below 25°C.</p> <p>If the problem persists after you have done all of the above checks, contact your dealer.</p>
The preferential kWh rate power supply settings and electrical connections do NOT match	<p>This should match with the connections as explained in:</p> <ul style="list-style-type: none"> ▪ "9.3.2 To connect the main power supply" [▶ 80] ▪ "9.1.4 About preferential kWh rate power supply" [▶ 74] ▪ "9.1.5 Overview of electrical connections except external actuators" [▶ 75]
The preferential kWh rate signal was sent by the electricity company	<p>In the user interface of the unit, go to [8.5.B] Information > Actuators > Forced off contact.</p> <p>If Forced off contact is On, the unit is operating under the preferential kWh rate. Wait for the power to return (maximum 2 hours).</p>

14.3.4 Symptom: The system is making gurgling noises after commissioning



Possible cause	Corrective action
There is air in the system.	Purge air from the system. ^(a)

Possible cause	Corrective action
Incorrect hydraulic balance.	To be performed by the installer: <ol style="list-style-type: none"> 1 Perform hydraulic balancing to assure that the flow is correctly distributed between the emitters. 2 If hydraulic balancing is not sufficient, change the pump limitation settings ([9-0D] and [9-0E] if applicable).
Various malfunctions.	Check if  or  is displayed on the home screen of the user interface. See "14.4.1 To display the help text in case of a malfunction" [▶ 205] for more information about the malfunction.

^(a) We recommend to purge air with the air purge function of the unit (to be performed by the installer). If you purge air from the heat emitters or collectors, mind the following:



WARNING

Air purging heat emitters or collectors. Before you purge air from heat emitters or collectors, check if  or  is displayed on the home screen of the user interface.

- If not, you can purge air immediately.
- If yes, make sure that the room where you want to purge air is sufficiently ventilated. **Reason:** Refrigerant might leak into the water circuit, and subsequently into the room when you purge air from the heat emitters or collectors.

14.3.5 Symptom: The pump is blocked

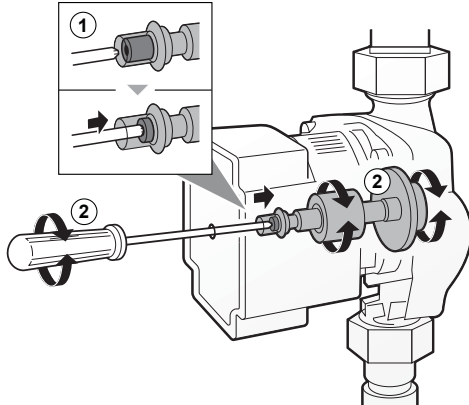
Possible causes	Corrective action
If the unit has been powered off for a long time, lime might block the rotor of the pump.	Use a Philips No. 2 screwdriver to push the deblocking screw of the rotor in (0.5 cm). Then turn the deblocking screw back and forth until the rotor is deblocked. ^(a) Note: Do NOT use excessive force. 

^(a) If you cannot deblock the rotor of the pump with this method, you will need to disassemble the pump and turn the rotor by hand.

14.3.6 Symptom: The pump is making noise (cavitation)

Possible causes	Corrective action
There is air in the system	Purge air manually (see "To perform a manual air purge" [▶ 190]) or use the automatic air purge function (see "To perform an automatic air purge" [▶ 190]).
The water pressure at the pump inlet is too low	Check and make sure that: <ul style="list-style-type: none"> ▪ The water pressure is >1 bar. ▪ The water pressure sensor is NOT broken. ▪ The expansion vessel is NOT broken. ▪ The pre-pressure setting of the expansion vessel is correct (see "8.1.4 Changing the pre-pressure of the expansion vessel" [▶ 64]).

14.3.7 Symptom: The pressure relief valve opens

Possible causes	Corrective action
The expansion vessel is broken	Replace the expansion vessel.
The water volume in the installation is too high	Make sure that the water volume in the installation is below the maximum allowed value (see "8.1.3 To check the water volume and flow rate" [▶ 61] and "8.1.4 Changing the pre-pressure of the expansion vessel" [▶ 64]).
The water circuit head is too high	The water circuit head is the difference in height between the outdoor unit and the highest point of the water circuit. If the outdoor unit is located at the highest point of the installation, the installation height is considered 0 m. The maximum water circuit head is 5 m. Check the installation requirements.

14.3.8 Symptom: The water pressure relief valve leaks

Possible causes	Corrective action
Dirt is blocking the water pressure relief valve outlet	Check whether the pressure relief valve works correctly by turning the red knob on the valve counterclockwise: <ul style="list-style-type: none"> ▪ If you do NOT hear a clacking sound, contact your dealer. ▪ If the water keeps running out of the unit, close both the water inlet and outlet shut-off valves first and then contact your dealer.

14.3.9 Symptom: The space is NOT sufficiently heated at low outdoor temperatures

Possible causes	Corrective action
If the system contains a backup heater: The backup heater operation is not activated	<p>Check the following:</p> <ul style="list-style-type: none"> ▪ The backup heater operation mode is enabled. <p>Go to: [9.3.8]: Installer settings > Backup heater > Operation [4-00]</p> <ul style="list-style-type: none"> ▪ The backup heater overcurrent circuit breaker is on. If not, turn it back on. ▪ The thermal protector of the backup heater is NOT activated. If it has, check the following, and then press the reset button in the switch box: <ul style="list-style-type: none"> - The water pressure - Whether there is air in the system - The air purge operation
If the system contains a backup heater: The backup heater equilibrium temperature has not been configured correctly	<p>Increase the equilibrium temperature to activate the backup heater operation at a higher outdoor temperature.</p> <p>Go to: [9.3.7]: Installer settings > Backup heater > Equilibrium temperature [5-01]</p>
There is air in the system.	<p>Purge air manually or automatically. See the air purge function in the chapter "11 Commissioning" [▶ 186].</p>

14.3.10 Symptom: The pressure at the tapping point is temporarily unusually high

Possible causes	Corrective action
Failing or blocked pressure relief valve.	<ul style="list-style-type: none"> ▪ Flush and clean the complete tank including the piping between pressure relief valve and the cold water inlet. ▪ Replace the pressure relief valve.

14.4 Solving problems based on error codes

If the unit runs into a problem, the user interface displays an error code. It is important to understand the problem and to take measures before resetting an error code. This should be done by a licensed installer or by your local dealer.

This chapter gives you an overview of most possible error codes and their descriptions as they appear on the user interface.

**INFORMATION**

See the service manual for:

- The complete list of error codes
- A more detailed troubleshooting guideline for each error

14.4.1 To display the help text in case of a malfunction

In case of a malfunction, the following will appear on the home screen depending on the severity:

- : Error
- : Malfunction































You can get a short and a long description of the malfunction as follows:





























1	Press the left dial to open the main menu and go to Malfunctioning . Result: A short description of the error and the error code is displayed on the screen.	
2	Press ? in the error screen. Result: A long description of the error is displayed on the screen.	?











14.4.2 Error codes of the unit

= Compressor module, = Hydro module

Error code	Description	
7H-01		Water flow problem
7H-05		Water flow problem during heating/sampling
7H-06		Water flow problem during cooling/defrost
7H-07		Water flow problem. Pump deblocking active
7H-08		Pump abnormality during operation (pump feedback)
80-00		Returning water temperature sensor problem
80-01		Entering water thermistor abnormality of outdoor unit
81-00		Leaving water temperature sensor problem
81-01		Mixed water thermistor abnormality.
89-01		Heat exchanger freeze-up protection activated during defrost (error)
89-02		Heat exchanger freeze-up protection activated during heating / DHW operation. (warning)
89-03		Heat exchanger freeze-up protection activated during defrost (warning)
89-05		Heat exchanger freeze-up protection activated during cooling operation. (error)

Error code	Description	
89-06		Heat exchanger freeze-up protection activated during cooling operation. (warning)
8H-00		Abnormal increase outlet water temperature
8H-01		Overheating mixed water circuit
8H-02		Overheating mixed water circuit (thermostat)
8H-03		Overheating water circuit (thermostat)
A1-00		Zero cross detection problem
A5-00		OU: High pressure peak cut / freeze protection problem
AA-01		Backup heater overheated or BUH power cable not connected
C0-00		Flow sensor malfunction
C0-01		Flow sensor malfunction
C0-02		Flow sensor malfunction
C4-00		Heat exchanger temperature sensor problem
C5-00		Heat exchanger thermistor abnormality
CJ-02		Room temperature sensor problem
E1-00		OU: PCB defect
E2-00		Leakage current detection error
E3-00		OU: Actuation of high pressure switch (HPS)
E3-24		High pressure sensor abnormality
E4-00		Abnormal suction pressure
E5-00		OU: Overheat of inverter compressor motor
E6-00		OU: Compressor startup defect
E7-00		OU: Malfunction of outdoor unit fan motor
E8-00		OU: Power input overvoltage
E9-00		Malfunction of electronic expansion valve
EA-00		OU: Cool/heat switchover problem
F3-00		OU: Malfunction of discharge pipe temperature
F6-00		OU: Abnormal high pressure in cooling
FA-00		OU: Abnormal high pressure, actuation of HPS
H0-00		OU: Voltage/current sensor problem
H1-00		External temperature sensor problem
H3-00		OU: Malfunction of high pressure switch (HPS)

Error code		Description
H5-00		Malfunction of compressor overload protection
H6-00		OU: Malfunction of position detection sensor
H8-00		OU: Malfunction of compressor input (CT) system
H9-00		OU: Malfunction of outdoor air thermistor
HJ-10		Water pressure sensor abnormality
J3-00		OU: Malfunction of discharge pipe thermistor
J6-00		OU: Malfunction of heat exchanger thermistor
J6-07		OU: Malfunction of heat exchanger thermistor
J8-00		Malfunction of refrigerant liquid thermistor
JA-00		OU: Malfunction of high pressure sensor
JA-17		Refrigerant pressure sensor abnormality
L1-00		Malfunction of INV PCB
L3-00		OU: Electrical box temperature rise problem
L4-00		OU: Malfunction of inverter radiating fin temperature rise
L5-00		OU: Inverter instantaneous overcurrent (DC)
L8-00		Malfunction triggered by a thermal protection in the inverter PCB
L9-00		Prevention of compressor lock
LC-00		Malfunction in communication system of outdoor unit
P1-00		Open-phase power supply imbalance
P3-00		Abnormal direct current
P4-00		OU: Malfunction of radiating fin temperature sensor
PJ-00		Capacity setting mismatch
U0-00		OU: Shortage of refrigerant
U1-00		Malfunction by reverse phase/open-phase
U2-00		OU: Defect of power supply voltage
U3-00		Underfloor heating screed dryout function not completed correctly
U4-00		Indoor/outdoor unit communication problem
U5-00		User interface communication problem
U7-00		OU: Transmission malfunction between main CPU-INV CPU

Error code	Description	
U8-02		Connection with room thermostat lost
U8-03		No connection with room thermostat
U8-04		Unknown USB device
U8-05		File malfunction
U8-06		MMI/bizone kit communication problem
U8-07		P1P2 communication error
U8-09		MMI software version {version_MMI_software} / Indoor unit [version_IU_modelname] compatibility error
U8-11		Connection with the Wireless gateway lost
UA-00		Indoor unit, outdoor unit matching problem
UF-00		Reversed piping or bad communication wiring detection.



NOTICE

When the minimum water flow is lower than described in the table below, the unit will temporarily stop operation and the user interface will display error 7H-01. After some time, this error will reset automatically and the unit will resume operation.

If operation is...	Then the minimum required flow rate is...
Cooling	10 l/min
Heating	6 l/min
BUH operation	12 l/min
Heating defrost	12 l/min



INFORMATION

If error 89-05 or 89-06 occurs, check the minimum water volume during cooling.



INFORMATION

If an U8-04 error occurs, the error can be reset after a successful update of the software. If the software is not successfully updated then you must make sure that your USB device has the FAT32 format.



INFORMATION

If the booster heater overheats and is disabled by the thermostatic safety, the unit will not give an error directly. Check if the booster heater is still in operation if you experience one or more of the following errors:

- Powerful operation takes a very long time to heat up and the error code AJ-03 is displayed.
- During anti-legionella operation (weekly), the error code AH-00 is displayed because the unit cannot reach the requested temperature required for tank disinfection.

**INFORMATION**

A malfunctioning booster heater will have an impact on energy metering and power consumption control.

**INFORMATION**

The user interface will display how to reset an error code.

15 Disposal



NOTICE

Do NOT try to dismantle the system yourself: dismantling of the system, treatment of the refrigerant, oil and other parts MUST comply with applicable legislation. Units MUST be treated at a specialised treatment facility for reuse, recycling and recovery.

In this chapter

15.1	Overview: Disposal	210
15.2	To pump down	210

15.1 Overview: Disposal

Typical workflow

Disposing of the system typically consists of the following stages:

- 1 Pumping down the system.
- 2 Bringing the system to a specialized treatment facility.



INFORMATION

For more details, see the service manual.

15.2 To pump down

Example: To protect the environment, pump down when relocating the unit or when disposing of the unit.



DANGER: RISK OF EXPLOSION

Pump down – Refrigerant leakage. If you want to pump down the system, and there is a leak in the refrigerant circuit:

- Do NOT use the unit's automatic pump down function, with which you can collect all refrigerant from the system into the outdoor unit. **Possible consequence:** Self-combustion and explosion of the compressor because of air going into the operating compressor.
- Use a separate recovery system so that the unit's compressor does NOT have to operate.



NOTICE

During pump down operation, stop the compressor before removing the refrigerant piping. If the compressor is still running and the stop valve is open during pump down, air will be sucked into the system. Compressor breakdown or damage to the system can result due to abnormal pressure in the refrigerant cycle.

**NOTICE**

Before pump down. Before using the unit's automatic pump down function, do the following settings:

- Set [7-02]=1 (or [4.4]: **Space heating/cooling > Number of zones = Dual zone**)
- Set [C-07]=0 (or [2.9]: **Main zone > Control = Leaving water**)
- Set [E-08]=0 (or [9.F]: **Installer settings > Power saving function = No**)

Pump down operation will extract all refrigerant from the system into the outdoor unit.

- 1 Remove the valve lid from the liquid stop valve and the gas stop valve.
- 2 Install a manifold on the gas stop valve.
- 3 Start the pump down operation via the user interface integrated in the indoor unit:

1	Set the user permission level to Installer . See " To change the user permission level " [▶ 104].	—
2	Go to [A.5]: Commissioning > Pump down .	
3	Select Pump down .	
4	Select OK to confirm. Result: The pump down operation starts. It stops automatically when done.	
	To stop the pump down operation manually:	—
1	In the menu, go to Stop pump down .	
2	Select OK to confirm.	

- 4 After 5 to 10 minutes (after only 1 or 2 minutes in case of very low ambient temperatures (<math><-10^{\circ}\text{C}</math>)), close the liquid stop valve with a hexagonal wrench.
- 5 Check on the manifold if the vacuum is reached.
- 6 After 2-3 minutes, close the gas stop valve and stop the pump down operation.

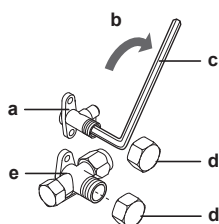

- a** Liquid stop valve
- b** Closing direction
- c** Hexagonal wrench
- d** Valve lid
- e** Gas stop valve

16 Technical data

A **subset** of the latest technical data is available on the regional Daikin website (publicly accessible). The **full set** of latest technical data is available on the Daikin Business Portal (authentication required).

In this chapter

16.1	Piping diagram: Outdoor unit.....	213
16.2	Wiring diagram: Outdoor unit.....	214
16.3	ESP curve: Outdoor unit	222

16.1 Piping diagram: Outdoor unit

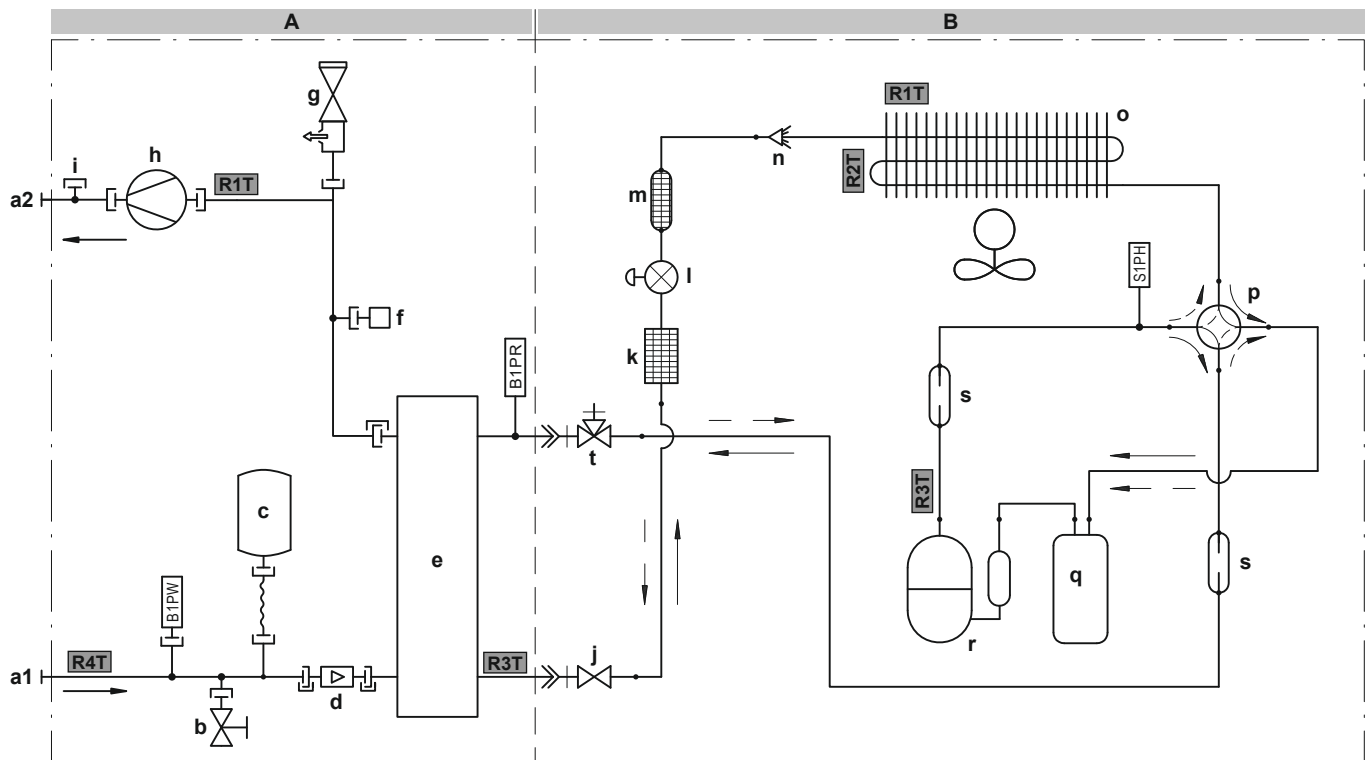

3D139353 B

A Hydro module**B Compressor module**

- a1** Water IN (screw connection, male, 1")
- a2** Water OUT (screw connection, male, 1")
- b** Drain valve (water circuit)
- c** Expansion vessel
- d** Flow sensor
- e** Plate heat exchanger
- f** Automatic air purge valve
- g** Safety valve
- h** Pump
- i** Connection for optional flow switch
- j** Liquid stop valve
- k** Filter
- l** Electronic expansion valve
- m** Muffler with filter
- n** Distributor
- o** Heat exchanger
- p** 4-way valve
- q** Accumulator
- r** Compressor
- s** Muffler
- t** Gas stop valve with service port

B1PW Space heating water pressure sensor**B1PR** Refrigerant pressure sensor**S1PH** High pressure switch**Thermistors (hydro module):****R1T** Outlet water heat exchanger**R3T** Refrigerant liquid side**R4T** Inlet water**Thermistors (compressor module):****R1T** Outdoor air**R2T** Compressor discharge**R3T** Compressor suction**Refrigerant flow:**

→ Heating

⇝ Cooling

Connections:

⊥ Screw connection

⇝ Flare connection

⊥ Quick coupling





● Brazed connection

16.2 Wiring diagram: Outdoor unit

Compressor module

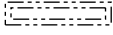
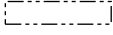
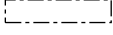
See the internal wiring diagram supplied with the unit (on the inside of the front plate). The abbreviations used are listed below.

Translation of text on wiring diagram:

English	Translation
(1) Connection diagram	(1) Connection diagram
Outdoor	Outdoor
Hydro	Hydro module
(2) Notes	(2) Notes
	Connection
X1M	Main terminal
-----	Earth wiring
-----	Field supply
	Option
	Wiring depending on model
	Switch box
	PCB
	Protective earth
	Field wire
(3) Legend	(3) Legend
	*: Optional; #: Field supply
A1P	Hydro kit main PCB
AL*	Connector
C*	Capacitor
DB*	Rectifier bridge
DC*	Connector
DP*	Connector
E*	Connector
F1U	Fuse T 6.3 A 250 V
FU1, FU2	Fuse T 3.15 A 250 V
FU3	Fuse T 30 A 250 V
H*	Connector
IPM*	Intelligent power module
L	Connector
LED A	Pilot lamp
L*	Reactor
M1C	Compressor motor

English		Translation
M1F		Fan motor
MR*		Magnetic relay
N		Connector
PCB1		Printed circuit board (main)
PS		Switching power supply
Q1L		Thermal protector
Q1DI	#	Earth leakage circuit breaker
Q*		Insulated gate bipolar transistor (IGBT)
R1T		Thermistor (air)
R2T		Thermistor (heat exchanger)
R3T		Thermistor (discharge)
RTH2		Resistor
S		Connector
S1PH		High pressure switch
S2~80		Connector
SA1		Surge arrester
SHM		Terminal strip fixed plate
U, V, W		Connector
V3, V4, V401		Varistor
X*A		Connector
X*M		Terminal strip
Y1E		Electronic expansion valve
Y1S		Solenoid valve (4-way valve)
Z*C		Noise filter (ferrite core)
Z*F		Noise filter

NOTES:

- 1 When operating, do not short-circuit protection device(s) S1PH and Q1L.
- 2 Colours: BLK: black; RED: red; BLU: blue; WHT: white; GRN: green; YLW: yellow

Hydro module

The wiring diagram is delivered with the unit, located at the inside of the service cover.

Translation of text on wiring diagram:

English	Translation
(1) Connection diagram	(1) Connection diagram
Hydro	Hydro module
Outdoor	Outdoor
1N~, 230 V, 3/6 kW	1N~, 230 V, 3 kW or 6 kW
3N~, 400 V, 6/9 kW	3N~, 400 V, 6 kW or 9 kW
2-point SPST valve	2-point SPST valve
Booster heater power supply	Booster heater power supply
Compressor switch box	Compressor switch box
External BUH	External backup heater
For DHW tank option (only ***)	For DHW tank option (only ***)
For external BUH option	For external backup heater option
For normal power supply (standard)	For normal power supply (standard)
For preferential kWh rate power supply (outdoor)	For preferential kWh rate power supply (outdoor)
Hydro SWB power supplied from compressor SWB	Hydro switch box power supplied from compressor switch box
Normal kWh rate power supply	Normal kWh rate power supply
SWB	Switch box
Use normal kWh rate power supply for hydro SWB	Use normal kWh rate power supply for hydro switch box
(2) Hydro SWB layout	(2) Hydro switch box layout
For external BUH model	For external backup heater model
For internal BUH model	For internal backup heater model
Rear	Rear
(3) Notes	(3) Notes
X1M	Main terminal
X2M	Field wiring terminal for AC
X3M	External backup heater terminal
X4M	Booster heater power supply terminal
X5M	Field wiring terminal for DC
X9M	Internal backup heater power supply terminal
X10M	Smart Grid terminal
-----	Earth wiring
-----	Field supply

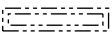
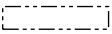
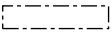
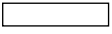
English	Translation
①	Several wiring possibilities
	Option
	Wiring depending on model
	Switch box
	PCB
Legend	(4) Legend
	*: Optional; #: Field supply
A1P	Main PCB
A2P	* ON/OFF thermostat (PC=power circuit)
A3P	* Heat pump convector
A4P	* Digital I/O PCB
A8P	* Demand PCB
A11P	MMI (= standalone user interface delivered as accessory) – Main PCB
A13P	* LAN adapter
A14P	* User interface PCB
A15P	* Receiver PCB (wireless ON/OFF thermostat)
CN* (A4P)	* Connector
DS1 (A8P)	* DIP switch
E*P (A9P)	Indication LED
F1B	# Overcurrent fuse backup heater
F2B	Overcurrent fuse booster heater
F1U, F2U (A4P)	* Fuse 5 A 250 V for digital I/O PCB
K1A, K2A	* High voltage Smart Grid relay
K1M	Contactors backup heater
K3M	* Contactor booster heater
K*R (A4P)	Relay on PCB
M2P	# Domestic hot water pump
M2S	# 2-way valve for cooling mode
M3S	* 3-way valve for floorheating / domestic hot water
M4S	* Valve kit
PC (A15P)	* Power circuit
PHC1 (A4P)	* Optocoupler input circuit
Q2L	* Thermal protector booster heater
Q4L	# Safety thermostat
Q*DI	# Earth leakage circuit breaker

English		Translation
R1H (A2P)	*	Humidity sensor
R1T (A2P)	*	Ambient sensor ON/OFF thermostat
R1T (A14P)	*	Ambient sensor user interface
R2T (A2P)	*	External sensor (floor or ambient)
R5T	*	Domestic hot water thermistor
R6T	*	External indoor or outdoor ambient thermistor
S1L	*	Flow switch
S1S	#	Preferential kWh rate power supply contact
S2S	#	Electricity meter pulse input 1
S3S	#	Electricity meter pulse input 2
S4S	#	Smart Grid feed-in
S6S~S9S	*	Digital power limitation inputs
S10S, S11S	#	Low voltage Smart Grid contact
SS1 (A4P)	*	Selector switch
TR1		Power supply transformer
X4M	*	Terminal strip (booster heater power supply)
X8M	#	Terminal strip (power supply at client side)
X9M		Terminal strip (integrated backup heater power supply)
X10M	*	Terminal strip (Smart Grid power supply)
X*, X*A, X*Y		Connector
X*M		Terminal strip
Z*C		Noise filter (ferrite core)
(5) Option PCBs		(5) Option PCBs
Alarm output		Alarm output
Changeover to ext. heat source		Changeover to external heat source
For demand PCB option		For demand PCB option
For digital I/O PCB option		For digital I/O PCB option
Max. load		Maximum load
Min. load		Minimum load
Power limitation digital inputs: 12 V DC / 12 mA detection (voltage supplied by PCB)		Power limitation digital inputs: 12 V DC / 12 mA detection (voltage supplied by PCB)
Options: ext. heat source output, alarm output		Options: external heat source output, alarm output

English	Translation
Options: On/OFF output	Options: On/OFF output
Space C/H On/OFF output	Space cooling/heating On/OFF output
SWB	Switch box
(6) Options	(6) Options
230 V AC Control Device	230 V AC control device
Continuous	Continuous current
DHW pump output	Domestic hot water pump output
Electric pulse meter input: 12 V DC pulse detection (voltage supplied by PCB)	Electric pulse meter input: 12 V DC pulse detection (voltage supplied by PCB)
Ext. ambient sensor option (indoor or outdoor)	External ambient sensor option (indoor or outdoor)
For cooling mode	For cooling mode
For HP tariff	For heat pump tariff
For HV smartgrid	For high voltage Smart Grid
For LV smartgrid	For low voltage Smart Grid
For safety thermostat	For safety thermostat
For smartgrid	For Smart Grid
For ***	For ***
Inrush	Inrush current
NO valve	Normal open valve
Only for LAN adapter	Only for LAN adapter
Optional for ***	Optional for ***
Preferential kWh rate power supply contact: 16 V DC detection (voltage supplied by PCB)	Preferential kWh rate power supply contact: 16 V DC detection (voltage supplied by PCB)
Remote user interface	Remote user interface
Safety thermostat contact: 16 V DC detection (voltage supplied by PCB)	Safety thermostat contact: 16 V DC detection (voltage supplied by PCB)
Smartgrid contacts	Smart Grid contacts
Smartgrid PV power pulse meter	Smart Grid photovoltaic power pulse meter
SWB	Switch box
(7) External On/OFF thermostats and heat pump convector	(7) External On/OFF thermostats and heat pump convector
Additional LWT zone	Additional leaving water temperature zone
Main LWT zone	Main leaving water temperature zone
Only for ext. sensor (floor or ambient)	Only for external sensor (floor or ambient)

English	Translation
Only for heat pump convector	Only for heat pump convector
Only for wired On/OFF thermostat	Only for wired On/OFF thermostat
Only for wireless On/OFF thermostat	Only for wireless On/OFF thermostat
Only for ***	Only for ***

Electrical connection diagram

For more details, please check the unit wiring.

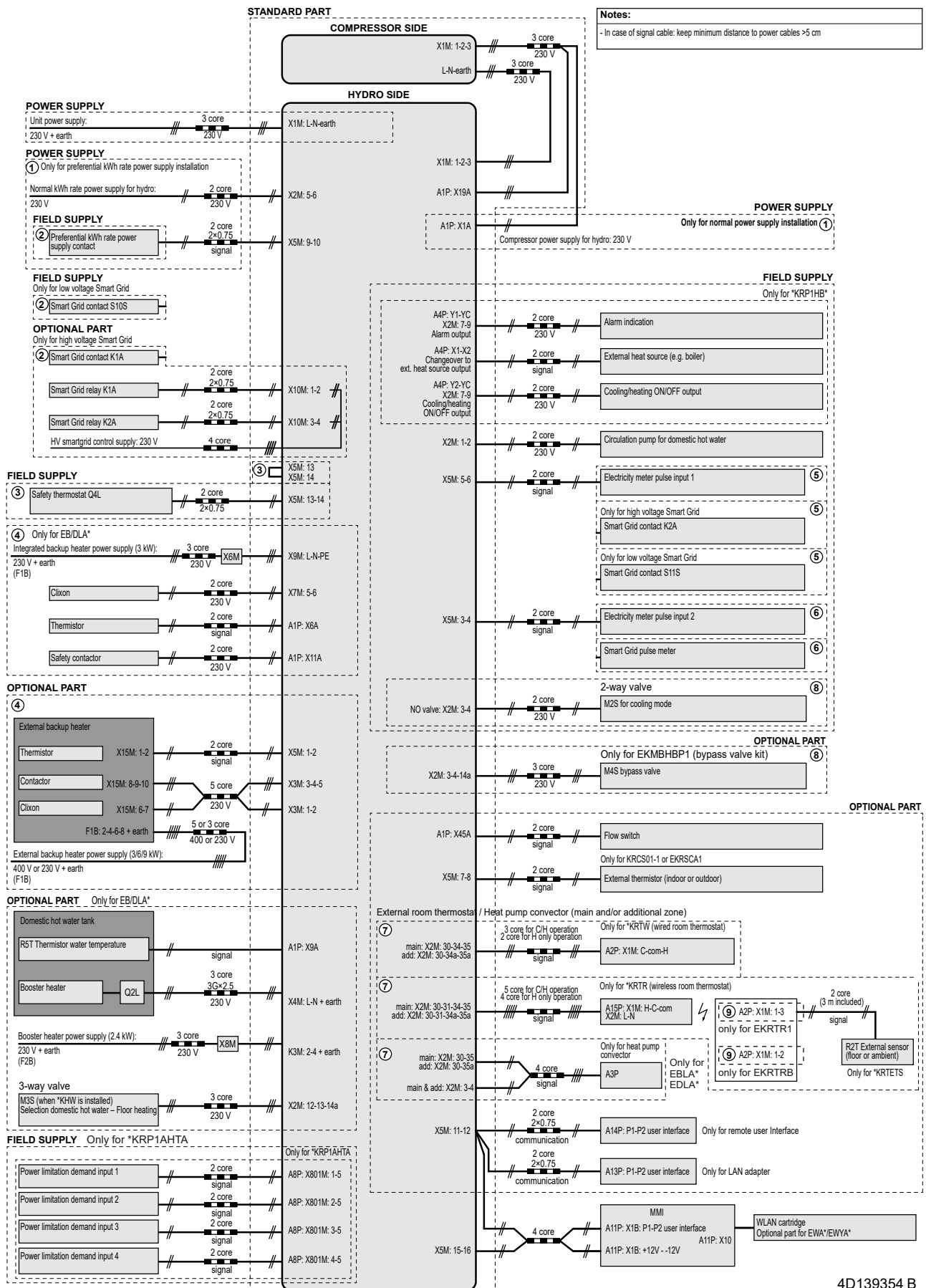

4D139354 B

16.3 ESP curve: Outdoor unit

Note: A flow error will occur when the minimum water flow rate is not reached.

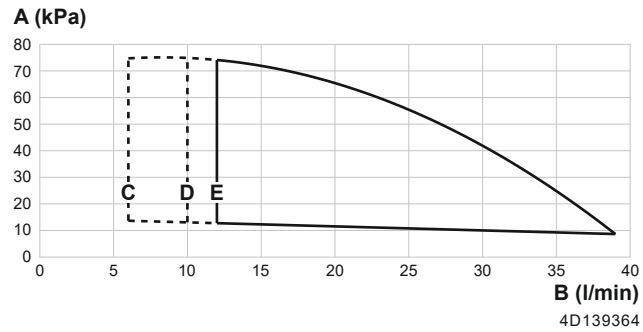

- A** External static pressure
- B** Water flow rate
- C** Minimum flow during normal operation
- D** Minimum flow during Cooling operation
- E** Minimum flow during Defrost and Backup heater operation

Notes:

- Selecting a flow outside the operating area can damage the unit or cause the unit to malfunction. See also the minimum and maximum allowed water flow range in the technical specification.
- Water quality must be according to EU directive 2020/2184.

17 Glossary

Dealer

Sales distributor for the product.

Authorised installer

Technical skilled person who is qualified to install the product.

User

Person who is owner of the product and/or operates the product.

Applicable legislation

All international, European, national and local directives, laws, regulations and/or codes that are relevant and applicable for a certain product or domain.

Service company

Qualified company which can perform or coordinate the required service to the product.

Installation manual

Instruction manual specified for a certain product or application, explaining how to install, configure and maintain it.

Operation manual

Instruction manual specified for a certain product or application, explaining how to operate it.

Maintenance instructions

Instruction manual specified for a certain product or application, which explains (if relevant) how to install, configure, operate and/or maintain the product or application.

Accessories

Labels, manuals, information sheets and equipment that are delivered with the product and that need to be installed according to the instructions in the accompanying documentation.

Optional equipment

Equipment made or approved by Daikin that can be combined with the product according to the instructions in the accompanying documentation.

Field supply

Equipment NOT made by Daikin that can be combined with the product according to the instructions in the accompanying documentation.

Field settings table

Applicable indoor units

EWYA004D2V3P

EWYA006D2V3P

EWYA008D2V3P

EWYA004D2V3P-H

EWYA006D2V3P-H

EWYA008D2V3P-H

EWAA004D2V3P

EWAA006D2V3P

EWAA008D2V3P

EWAA004D2V3P-H

EWAA006D2V3P-H

EWAA008D2V3P-H

Notes

(*1) EWYA*

(*2) EWAA*

Field settings table					Installer setting at variance with default value	
Breadcrumb	Setting name		Range, step	Default value	Date	Value
Room						
└ Antifrost						
1.4.1	[2-06]	Activation	R/W	0: No 1: Yes		
1.4.2	[2-05]	Room setpoint	R/W	4~16°C, step: 1°C 12°C		
└ Setpoint range						
1.5.1	[3-07]	Heating minimum	R/W	12~18°C, step: 1°C 12°C		
1.5.2	[3-06]	Heating maximum	R/W	18~30°C, step: 1°C 30°C		
1.5.3	[3-09]	Cooling minimum	R/W	15~25°C, step: 1°C 15°C		
1.5.4	[3-08]	Cooling maximum	R/W	25~35°C, step: 1°C 35°C		
Room						
1.6	[2-09]	Room sensor offset	R/W	-5~5°C, step: 0,5°C 0°C		
1.7	[2-0A]	Room sensor offset	R/W	-5~5°C, step: 0,5°C 0°C		
└ Room comfort setpoint						
1.9.1	[9-0A]	Heating comfort setpoint	R/W	[3-07]~[3-06]°C, step: 0,5°C 23°C		
1.9.2	[9-0B]	Cooling comfort setpoint	R/W	[3-09]~[3-08]°C, step: 0,5°C 23°C		
Main zone						
2.4		Setpoint mode		0: Fixed 1: WD heating, fixed cooling 2: Weather dependent		
└ Heating WD curve						
2.5	[1-00]	Low ambient temp. for LWT main zone heating WD curve.	R/W	-40~5°C, step: 1°C -10°C		
2.5	[1-01]	High ambient temp. for LWT main zone heating WD curve.	R/W	10~25°C, step: 1°C 15°C		
2.5	[1-02]	Leaving water value for low ambient temp. for LWT main zone heating WD curve.	R/W	[9-01]~[9-00], step: 1°C [2-0C]=0 35°C [2-0C]=1 45°C [2-0C]=2 60°C		
2.5	[1-03]	Leaving water value for high ambient temp. for LWT main zone heating WD curve.	R/W	[9-01]~min(45, [9-00])°C, step: 1°C [2-0C]=0 25°C [2-0C]=1 35°C [2-0C]=2 40°C		
└ Cooling WD curve						
2.6	[1-06]	Low ambient temp. for LWT main zone cooling WD curve.	R/W	10~25°C, step: 1°C 20°C		
2.6	[1-07]	High ambient temp. for LWT main zone cooling WD curve.	R/W	25~43°C, step: 1°C 35°C		
2.6	[1-08]	Leaving water value for low ambient temp. for LWT main zone cooling WD curve.	R/W	[9-03]~[9-02]°C, step: 1°C [2-0C]=0 22°C [2-0C]=1 15°C [2-0C]=2 22°C		
2.6	[1-09]	Leaving water value for high ambient temp. for LWT main zone cooling WD curve.	R/W	[9-03]~[9-02]°C, step: 1°C [2-0C]=0 18°C [2-0C]=1 7°C [2-0C]=2 18°C		
Main zone						
2.7	[2-0C]	Emitter type	R/W	0: Underfloor heating 1: Fancoil unit 2: Radiator		
└ Setpoint range						
2.8.1	[9-01]	Heating minimum	R/W	15~37°C, step: 1°C 25°C		
2.8.2	[9-00]	Heating maximum	R/W ([2-0C] ≠ 2) R/O ([2-0C] = 2)	[2-0C]=2: 37~70, step: 1°C 65°C [2-0C]≠2: 37~55, step: 1°C 55°C		
2.8.3	[9-03]	Cooling minimum	R/W	5~18°C, step: 1°C 5°C		
2.8.4	[9-02]	Cooling maximum	R/W	18~22°C, step: 1°C 22°C		
Main zone						
2.9	[C-07]	Control	R/W	0: Leaving water 1: External room thermostat 2: Room thermostat		
2.A	[C-05]	Ext Thermostat type	R/W	1: 1 contact 2: 2 contacts		
└ Delta T						
2.B.1	[1-0B]	Delta T heating	R/W ([2-0C] ≠ 2) R/O ([2-0C] = 2)	3~10°C, step: 1°C [2-0C] ≠ 2 (Radiator) 5°C [2-0C] = 2 (Radiator) 10°C		
2.B.2	[1-0D]	Delta T cooling	R/W	3~10°C, step: 1°C 5°C		

Field settings table					Installer setting at variance with default value	
Breadcrumb	Setting name		Range, step Default value	Date	Value	
└─ Modulation						
2.C.1	[8-05]	Modulation	R/W	0: No 1: Yes		
2.C.2	[8-06]	Max modulation	R/W	0-10°C, step: 1°C 5°C		
Main zone						
2.E		WD curve type	R/W	0: 2-points 1: Slope-Offset		
Additional zone						
3.4		Setpoint mode		0: Fixed 1: WD heating, fixed cooling 2: Weather dependent		
└─ Heating WD curve						
3.5	[0-00]	Leaving water value for high ambient temp. for LWT add zone heating WD curve.	R/W	[9-05]-min(45,[9-06])°C, step: 1°C [2-0C]=0 25°C [2-0C]=1 35°C [2-0C]=2 40°C		
3.5	[0-01]	Leaving water value for low ambient temp. for LWT add zone heating WD curve.	R/W	[9-05]-[9-06]°C, step: 1°C [2-0C]=0 35°C [2-0C]=1 45°C [2-0C]=2 60°C		
3.5	[0-02]	High ambient temp. for LWT add zone heating WD curve.	R/W	10-25°C, step: 1°C 15°C		
3.5	[0-03]	Low ambient temp. for LWT add zone heating WD curve.	R/W	-40-5°C, step: 1°C -10°C		
└─ Cooling WD curve						
3.6	[0-04]	Leaving water value for high ambient temp. for LWT add zone cooling WD curve.	R/W	[9-07]-[9-08]°C, step: 1°C [2-0C]=0 18°C [2-0C]=1 7°C [2-0C]=2 18°C		
3.6	[0-05]	Leaving water value for low ambient temp. for LWT add zone cooling WD curve.	R/W	[9-07]-[9-08]°C, step: 1°C [2-0C]=0 22°C [2-0C]=1 15°C [2-0C]=2 22°C		
3.6	[0-06]	High ambient temp. for LWT add zone cooling WD curve.	R/W	25-43°C, step: 1°C 35°C		
3.6	[0-07]	Low ambient temp. for LWT add zone cooling WD curve.	R/W	10-25°C, step: 1°C 20°C		
Additional zone						
3.7	[2-0D]	Emitter type	R/O	0: Underfloor heating 1: Fancoil unit 2: Radiator		
└─ Setpoint range						
3.8.1	[9-05]	Heating minimum	R/W	15-37°C, step: 1°C 25°C		
3.8.2	[9-06]	Heating maximum	R/W ([2-0C] ≠ 2) R/O ([2-0C] = 2)	[2-0C]=2: 37-70, step: 1°C 65°C [2-0C]≠2: 37-55, step: 1°C 55°C		
3.8.3	[9-07]	Cooling minimum	R/W	5-18°C, step: 1°C 7°C		
3.8.4	[9-08]	Cooling maximum	R/W	18-22°C, step: 1°C 22°C		
Additional zone						
3.A	[C-06]	Thermostat type	R/W	1: 1 contact 2: 2 contacts		
└─ Delta T						
3.B.1	[1-0C]	Delta T heating	[2-0D] ≠ 2 R/W [2-0D] = 2 R/O	[2-0D] ≠ 2 (Radiator) 3-10°C, step: 1°C 5°C [2-0D] = 2 (Radiator) 10°C		
3.B.2	[1-0E]	Delta T cooling	R/W	3-10°C, step: 1°C 5°C		
Additional zone						
3.C		WD curve type	R/O	0: 2-points 1: Slope-Offset		
Space heating / cooling						
└─ Operation range						
4.3.1	[4-02]	Space heating OFF temp	R/W	14-35°C, step: 1°C 22°C		
4.3.2	[F-01]	Space cooling OFF temp	R/W	10-35°C, step: 1°C 20°C		
Space heating / cooling						
4.4	[7-02]	Number of zones	R/W	0: Single zone 1: Dual zone		
4.5	[F-0D]	Pump operation mode	R/W	0: Continuous 1: Sample 2: Request		
4.6	[E-02]	Unit type	R/W (*1) R/O (*2)	0: Reversible (*1) 1: Cooling only (*2)		

Field settings table					Installer setting at variance with default value	
Breadcrumb	Setting name		Range, step	Default value	Date	Value
4.7	[9-0D]	Pump speed limitation	R/W	0-8, step:1 0 : No limitation 1-4 : 90-60% pump speed 5-8 : 90-60% pump speed during sampling 6 80% pump speed		
Space heating / cooling						
4.9	[F-00]	Pump outside range	R/W	0: Restricted 1: Allowed		
4.A	[D-03]	Increase around 0°C	R/W	0: No 1: increase 2°C, span 4°C 2: increase 4°C, span 4°C 3: increase 2°C, span 8°C 4: increase 4°C, span 8°C		
4.B	[9-04]	Overshoot	R/W	1-4°C, step: 1°C 1°C		
4.C	[2-06]	Antifrost	R/W	0: No 1: Yes		
User settings						
└ Quiet						
7.4.1		Mode	R/W	0: OFF 1: Manual 2: Automatic		
7.4.3		Level	R/W	0: Quiet 1: More Quiet 2: Most Quiet		
└ Electricity price						
7.5.1		High	R/W	0,00-990/kWh 1/kWh		
7.5.2		Medium	R/W	0,00-990/kWh 1/kWh		
7.5.3		Low	R/W	0,00-990/kWh 1/kWh		
User settings						
7.6		Gas price	R/W	0,00-990/kWh 0,00-290/MBtu 1.0/kWh		
Installer settings						
└ Configuration wizard						
└ System						
9.1.3.2	[E-03]	BUH type	R/W	0: No heater 1: External heater		
9.1.3.3	[E-05] [E-06] [E-07]	Domestic hot water	R/O	No DHW		
9.1.3.4	[4-06]	Emergency	R/W	0: Manual 1: Automatic 2: Auto SH reduced/ DHW ON 3: Auto SH reduced/ DHW OFF 4: Auto SH normal/ DHW OFF		
9.1.3.5	[7-02]	Number of zones	R/W	0: Single zone 1: Dual zone		
9.1.3.6	[E-0D]	Glycol Filled system	R/W	0: No 1: Yes		
└ Backup heater						
9.1.4.1	[5-0D]	Voltage	R/W	0: 230V, 1~ 1: 230V, 3~ 2: 400V, 3~		
9.1.4.2	[4-0A]	Configuration	R/W	0: 1 1: 1/1+2 2: 1/2 3: 1/2 + 1/1+2 in emergency		
9.1.4.3	[6-03]	Capacity step 1	R/W	0-10kW, step: 0,2kW 0kW		
9.1.4.4	[6-04]	Additional capacity step 2	R/W	0-10kW, step: 0,2kW 0kW		
└ Main zone						
9.1.5.1	[2-0C]	Emitter type	R/W	0: Underfloor heating 1: Fancoil unit 2: Radiator		
9.1.5.2	[C-07]	Control	R/W	0: Leaving water 1: External room thermostat 2: Room thermostat		
9.1.5.3		Setpoint mode	R/W	0: Fixed 1: WD heating, fixed cooling 2: Weather dependent		
9.1.5.4		Schedule	R/W	0: No 1: Yes		
9.1.5.5		WD curve type	R/W	0: 2-points 1: Slope-Offset		
9.1.6	[1-00]	Low ambient temp. for LWT main zone heating WD curve.	R/W	-40-5°C, step: 1°C -10°C		
9.1.6	[1-01]	High ambient temp. for LWT main zone heating WD curve.	R/W	10-25°C, step: 1°C 15°C		
9.1.6	[1-02]	Leaving water value for low ambient temp. for LWT main zone heating WD curve.	R/W	[9-01]-[9-00], step: 1°C [2-0C]=0 35°C [2-0C]=1 45°C [2-0C]=2 60°C		
9.1.6	[1-03]	Leaving water value for high ambient temp. for LWT main zone heating WD curve.	R/W	[9-01]-min(45, [9-00])°C, step: 1°C [2-0C]=0 25°C [2-0C]=1 35°C [2-0C]=2 40°C		

Field settings table					Installer setting at variance with default value	
Breadcrumb	Setting name	Range, step	Default value	Date	Value	
9.1.7	[1-06]	Low ambient temp. for LWT main zone cooling WD curve.	R/W	10~25°C, step: 1°C 20°C		
9.1.7	[1-07]	High ambient temp. for LWT main zone cooling WD curve.	R/W	25~43°C, step: 1°C 35°C		
9.1.7	[1-08]	Leaving water value for low ambient temp. for LWT main zone cooling WD curve.	R/W	[9-03]~[9-02]°C, step: 1°C [2-0C]=0 22°C [2-0C]=1 15°C [2-0C]=2 22°C		
9.1.7	[1-09]	Leaving water value for high ambient temp. for LWT main zone cooling WD curve.	R/W	[9-03]~[9-02]°C, step: 1°C [2-0C]=0 18°C [2-0C]=1 7°C [2-0C]=2 18°C		
↳ Additional zone						
9.1.8.1	[2-0D]	Emitter type	R/W	0: Underfloor heating 1: Fancoil unit 2: Radiator		
9.1.8.3		Setpoint mode	R/W	0: Fixed 1: WD heating, fixed cooling 2: Weather dependent		
9.1.8.4		Schedule	R/W	0: No 1: Yes		
9.1.9	[0-00]	Leaving water value for high ambient temp. for LWT add zone heating WD curve.	R/W	[9-05]~min(45,[9-06])°C, step: 1°C [2-0C]=0 25°C [2-0C]=1 35°C [2-0C]=2 40°C		
9.1.9	[0-01]	Leaving water value for low ambient temp. for LWT add zone heating WD curve.	R/W	[9-05]~[9-06]°C, step: 1°C [2-0C]=0 35°C [2-0C]=1 45°C [2-0C]=2 60°C		
9.1.9	[0-02]	High ambient temp. for LWT add zone heating WD curve.	R/W	10~25°C, step: 1°C 15°C		
9.1.9	[0-03]	Low ambient temp. for LWT add zone heating WD curve.	R/W	-40~5°C, step: 1°C -10°C		
9.1.A	[0-04]	Leaving water value for high ambient temp. for LWT add zone cooling WD curve.	R/W	[9-07]~[9-08]°C, step: 1°C [2-0C]=0 18°C [2-0C]=1 7°C [2-0C]=2 18°C		
9.1.A	[0-05]	Leaving water value for low ambient temp. for LWT add zone cooling WD curve.	R/W	[9-07]~[9-08]°C, step: 1°C [2-0C]=0 22°C [2-0C]=1 15°C [2-0C]=2 22°C		
9.1.A	[0-06]	High ambient temp. for LWT add zone cooling WD curve.	R/W	25~43°C, step: 1°C 35°C		
9.1.A	[0-07]	Low ambient temp. for LWT add zone cooling WD curve.	R/W	10~25°C, step: 1°C 20°C		
↳ Domestic hot water						
9.2.1	[E-05] [E-06] [E-07]	Domestic hot water	R/O	No DHW		
9.2.2	[D-02]	DHW pump	R/O	0: No DHW pump 1: Instant hot water 2: Disinfection 3: Circulation 4: Circulation and disinfection		
9.2.4	[D-07]	Solar	R/O	0: No 1: Yes (DHW)		
↳ Back up heater						
9.3.1	[E-03]	BUH type	R/W	0: No heater 1: External heater		
9.3.2	[5-0D]	Voltage	R/W	0: 230V, 1~ 1: 230V, 3~ 2: 400V, 3~		
9.3.3	[4-0A]	Configuration	R/W	0: 1 1: 1/1+2 2: 1/2 3: 1/2 + 1/1+2 in emergency		
9.3.4	[6-03]	Capacity step 1	R/W	0~10kW, step: 0,2kW 0kW		
9.3.5	[6-04]	Additional capacity step 2	R/W	0~10kW, step: 0,2kW 0kW		
9.3.6	[5-00]	Equilibrium: Deactivate backup heater (or external backup heat source)	R/W	0: No 1: Yes		
9.3.7	[5-01]	Equilibrium temperature	R/W	-15~35°C, step: 1°C 0°C		
9.3.8	[4-00]	Operation	R/W	0: Restricted 1: Allowed 2: Only DHW		
↳ Booster heater						
9.4.1	[6-02]	Capacity	R/O	0~10kW, step: 0,2kW 0kW		

Field settings table					Installer setting at variance with default value	
Breadcrumb	Setting name	Range, step	Default value	Date	Value	
9.4.3	[8-03]	BSH eco timer	R/W	20-95 min, step: 5 min 50 min		
9.4.4	[4-03]	Operation	R/W	0: Restricted 1: Allowed 2: Overlap 3: Compressor off 4: Legionella only		
└─ Emergency						
9.5.1	[4-06]	Emergency	R/W	0: Manual 1: Automatic 2: Auto SH reduced/ DHW ON 3: Auto SH reduced/ DHW OFF 4: Auto SH normal/ DHW OFF		
9.5.2	[7-06]	HP forced OFF	R/W	0: Disabled 1: Enabled		
Installer settings						
9.7	[4-04]	Water pipe freeze prevention	R/W	0: Continuous pump operation 1: Non continuous pump operation 2: OFF		
└─ Benefit kWh power supply						
9.8.2	[D-00]	Allow heater	R/W	0: No 1: Only BSH 2: Only BUH 3: All		
9.8.3	[D-05]	Allow pump	R/W	0: No 1: Yes		
9.8.4	[D-01]	Benefit kWh power supply	R/W	0: No 1: Open 2: Closed 3: Smart Grid		
9.8.6		Allow electric heaters	R/W	0: No 1: Yes		
9.8.7		Enable Room buffering	R/W	0: No 1: Yes		
9.8.8		Limit setting kW	R/W	0-20 kW, step: 0,5 kW 2 kW		
└─ Power consumption control						
9.9.1	[4-08]	Power consumption control	R/W	0: No 1: Continuous 2: Inputs 3: Current Sensor		
9.9.2	[4-09]	Type	R/W	0: Amp 1: kW		
9.9.3	[5-05]	Limit	R/W	0-50 A, step: 1 A 50 A		
9.9.4	[5-05]	Limit 1	R/W	0-50 A, step: 1 A 50 A		
9.9.5	[5-06]	Limit 2	R/W	0-50 A, step: 1 A 50 A		
9.9.6	[5-07]	Limit 3	R/W	0-50 A, step: 1 A 50 A		
9.9.7	[5-08]	Limit 4	R/W	0-50 A, step: 1 A 50 A		
9.9.8	[5-09]	Limit	R/W	0-20 kW, step: 0,5 kW 20 kW		
9.9.9	[5-09]	Limit 1	R/W	0-20 kW, step: 0,5 kW 20 kW		
9.9.A	[5-0A]	Limit 2	R/W	0-20 kW, step: 0,5 kW 20 kW		
9.9.B	[5-0B]	Limit 3	R/W	0-20 kW, step: 0,5 kW 20 kW		
9.9.C	[5-0C]	Limit 4	R/W	0-20 kW, step: 0,5 kW 20 kW		
9.9.D	[4-01]	Priority heater	R/W	0: None 1: Booster Heater 2: Backup Heater		
9.9.F	[7-07]	BBR16 activation* *BBR16 settings are only visible when the language of the user interface is set to Swedish.	R/W	0: No 1: Yes		
└─ Energy metering						
9.A.1	[D-08]	Electricity meter 1	R/W	0: No 1: 0,1 pulse/kWh 2: 1 pulse/kWh 3: 10 pulse/kWh 4: 100 pulse/kWh 5: 1000 pulse/kWh		
9.A.2	[D-09]	Electricity meter 2 / PV meter	R/W	0: No 1: 0,1 pulse/kWh 2: 1 pulse/kWh 3: 10 pulse/kWh 4: 100 pulse/kWh 5: 1000 pulse/kWh 6: 100 pulse/kWh (PV meter) 7: 1000 pulse/kWh (PV meter)		
└─ Sensors						
9.B.1	[C-08]	External sensor	R/W	0: No 1: Outdoor 2: Room		
9.B.2	[2-0B]	Ext. amb. sensor offset	R/W	-5-5°C, step: 0,5°C 0°C		
9.B.3	[1-0A]	Averaging time	R/W	0: No 1: 12 h 2: 24 h 3: 48 h 4: 72 h		
└─ Bivalent						
9.C.1	[C-02]	Bivalent	R/W	0: NO 1: Yes		

Field settings table					Installer setting at variance with default value	
Breadcrumb	Setting name		Range, step	Default value	Date	Value
9.C.2	[7-05]	Boiler efficiency	R/W	0: Very high 1: High 2: Medium 3: Low 4: Very low		
9.C.3	[C-03]	Temperature	R/W	-25~25°C, step: 1°C 0°C		
9.C.4	[C-04]	Hysteresis	R/W	2~10°C, step 1°C 3°C		
Installer settings						
9.D	[C-09]	Alarm output	R/W	0: Abnormal 1: Normal		
9.E	[3-00]	Auto restart	R/W	0: manual 1: automatic		
9.F	[E-08]	Power saving function	R/W	0: No 1: Yes		
9.G		Disable protections	R/W	0: No 1: Yes		
Overview field settings						
9.I	[0-00]	Leaving water value for high ambient temp. for LWT add zone heating WD curve.	R/W	[9-05]~min(45,[9-06])°C, step: 1°C [2-0C]=0 25°C [2-0C]=1 35°C [2-0C]=2 40°C		
9.I	[0-01]	Leaving water value for low ambient temp. for LWT add zone heating WD curve.	R/W	[9-05]~[9-06]°C, step: 1°C [2-0C]=0 35°C [2-0C]=1 45°C [2-0C]=2 60°C		
9.I	[0-02]	High ambient temp. for LWT add zone heating WD curve.	R/W	10~25°C, step: 1°C 15°C		
9.I	[0-03]	Low ambient temp. for LWT add zone heating WD curve.	R/W	-40~5°C, step: 1°C -10°C		
9.I	[0-04]	Leaving water value for high ambient temp. for LWT add zone cooling WD curve.	R/W	[9-07]~[9-08]°C, step: 1°C [2-0C]=0 18°C [2-0C]=1 7°C [2-0C]=2 18°C		
9.I	[0-05]	Leaving water value for low ambient temp. for LWT add zone cooling WD curve.	R/W	[9-07]~[9-08]°C, step: 1°C [2-0C]=0 22°C [2-0C]=1 15°C [2-0C]=2 22°C		
9.I	[0-06]	High ambient temp. for LWT add zone cooling WD curve.	R/W	25~43°C, step: 1°C 35°C		
9.I	[0-07]	Low ambient temp. for LWT add zone cooling WD curve.	R/W	10~25°C, step: 1°C 20°C		
9.I	[0-0B]	Leaving water value for high ambient temp. for DHW WD curve.	R/W	35~[6-0E]°C, step: 1°C 55°C		
9.I	[0-0C]	Leaving water value for low ambient temp. for DHW WD curve.	R/W	Min(45~[6-0E])~[6-0E]°C, step: 1°C 60°C		
9.I	[0-0D]	High ambient temp. for DHW WD curve.	R/W	10~25°C, step: 1°C 15°C		
9.I	[0-0E]	Low ambient temp. for DHW WD curve.	R/W	-40~5°C, step: 1°C -10°C		
9.I	[1-00]	Low ambient temp. for LWT main zone heating WD curve.	R/W	-40~5°C, step: 1°C -10°C		
9.I	[1-01]	High ambient temp. for LWT main zone heating WD curve.	R/W	10~25°C, step: 1°C 15°C		
9.I	[1-02]	Leaving water value for low ambient temp. for LWT main zone heating WD curve.	R/W	[9-01]~[9-00], step: 1°C [2-0C]=0 35°C [2-0C]=1 45°C [2-0C]=2 60°C		
9.I	[1-03]	Leaving water value for high ambient temp. for LWT main zone heating WD curve.	R/W	[9-01]~min(45, [9-00])°C, step: 1°C [2-0C]=0 25°C [2-0C]=1 35°C [2-0C]=2 40°C		
9.I	[1-04]	Weather dependent cooling of the main leaving water temperature zone.	R/W	0: Disabled 1: Enabled		
9.I	[1-05]	Weather dependent cooling of the additional leaving water temperature zone	R/W	0: Disabled 1: Enabled		
9.I	[1-06]	Low ambient temp. for LWT main zone cooling WD curve.	R/W	10~25°C, step: 1°C 20°C		
9.I	[1-07]	High ambient temp. for LWT main zone cooling WD curve.	R/W	25~43°C, step: 1°C 35°C		
9.I	[1-08]	Leaving water value for low ambient temp. for LWT main zone cooling WD curve.	R/W	[9-03]~[9-02]°C, step: 1°C [2-0C]=0 22°C [2-0C]=1 15°C [2-0C]=2 22°C		

Field settings table				Installer setting at variance with default value		
Breadcrumb	Setting name	Range, step	Default value	Date	Value	
9.I	[1-09]	Leaving water value for high ambient temp. for LWT main zone cooling WD curve.	R/W	[9-03]-[9-02]°C, step: 1°C [2-0C]=0 18°C [2-0C]=1 7°C [2-0C]=2 18°C		
9.I	[1-0A]	What is the averaging time for the outdoor temp?	R/W	0: No 1: 12 h 2: 24 h 3: 48 h 4: 72 h		
9.I	[1-0B]	What is the desired delta T in heating for the main zone?	R/W ([2-0C] ≠ 2) R/O ([2-0C] = 2)	3-10°C, step: 1°C [2-0C] ≠ 2 (Radiator) 5°C [2-0C] = 2 (Radiator) 10°C		
9.I	[1-0C]	What is the desired delta T in heating for the additional zone?	[2-0D] ≠ 2 R/W [2-0D] = 2 R/O	[2-0D] ≠ 2 (Radiator) 3-10°C, step: 1°C 5°C [2-0D] = 2 (Radiator) 10°C		
9.I	[1-0D]	What is the desired delta T in cooling for the main zone?	R/W	3-10°C, step: 1°C 5°C		
9.I	[1-0E]	What is the desired delta T in cooling for the additional zone?	R/W	3-10°C, step: 1°C 5°C		
9.I	[2-00]	When should the disinfection function be executed?	R/W	0: Each day 1: Monday 2: Tuesday 3: Wednesday 4: Thursday 5: Friday 6: Saturday 7: Sunday		
9.I	[2-01]	Should the disinfection function be executed?	R/W	0: No 1: Yes		
9.I	[2-02]	When should the disinfection function start?	R/W	0-23 hour, step: 1 hour 1		
9.I	[2-03]	What is the disinfection target temperature?	R/W	60°C 60°C		
9.I	[2-04]	How long must the tank temperature be maintained?	R/W	40-60 min, step: 5 min 10 min		
9.I	[2-05]	Room antifrost temperature	R/W	4-16°C, step: 1°C 12°C		
9.I	[2-06]	Room frost protection	R/W	0: No 1: Yes		
9.I	[2-09]	Adjust the offset on the measured room temperature	R/W	-5-5°C, step: 0,5°C 0°C		
9.I	[2-0A]	Adjust the offset on the measured room temperature	R/W	-5-5°C, step: 0,5°C 0°C		
9.I	[2-0B]	What is the required offset on the measured outdoor temp.?	R/W	-5-5°C, step: 0,5°C 0°C		
9.I	[2-0C]	What emitter type is connected to the main LWT zone?	R/W	0: Underfloor heating 1: Fancoil unit 2: Radiator		
9.I	[2-0D]	What emitter type is connected to the additional LWT zone?	R/W	0: Underfloor heating 1: Fancoil unit 2: Radiator		
9.I	[2-0E]	What is the maximum allowed current over the heatpump ?	R/W	20-50 A, step: 1 A 50 A		
9.I	[3-00]	Is auto restart of the unit allowed?	R/W	0: manual 1: automatic		
9.I	[3-01]	--	R/W	0		
9.I	[3-02]	--	R/W	1		
9.I	[3-03]	--	R/W	4		
9.I	[3-04]	--	R/W	2		
9.I	[3-05]	--	R/W	1		
9.I	[3-06]	What is the maximum desired room temperature in heating?	R/W	18-30°C, step: 1°C 30°C		
9.I	[3-07]	What is the minimum desired room temperature in heating?	R/W	12-18°C, step: 1°C 12°C		
9.I	[3-08]	What is the maximum desired room temperature in cooling?	R/W	25-35°C, step: 1°C 35°C		
9.I	[3-09]	What is the minimum desired room temperature in cooling?	R/W	15-25°C, step: 0,5 1°C 15°C		
9.I	[3-0A]	What is the pump model	R/O	0: pump model 0 1: pump model 1		
9.I	[4-00]	What is the BUH operation mode?	R/W	0: Restricted 1: Allowed 2: Only DHW		
9.I	[4-01]	Which electric heater has priority?	R/W	0: None 1: Booster Heater 2: Backup Heater		
9.I	[4-02]	Below which outdoor temperature is heating allowed?	R/W	14-35°C, step: 1°C 22°C		
9.I	[4-03]	Operation permission of the booster heater.	R/W	0: Restricted 1: Allowed 2: Overlap 3: Compressor off 4: Legionella only		
9.I	[4-04]	Water pipe freeze prevention	R/W	0: Continuous pump operation 1: Non continuous pump operation 2: OFF		
9.I	[4-05]	--		0		

Field settings table					Installer setting at variance with default value	
Breadcrumb	Setting name	Range, step	Default value	Date	Value	
9.1	[4-06]	Emergency	R/W	0: Manual 1: Automatic 2: Auto SH reduced/ DHW ON 3: Auto SH reduced/ DHW OFF 4: Auto SH normal/ DHW OFF		
9.1	[4-07]	--		3		
9.1	[4-08]	Which power limitation mode is required on the system?	R/W	0: No 1: Continuous 2: Inputs 3: Current Sensor		
9.1	[4-09]	Which power limitation type is required?	R/W	0: Amp 1: kW		
9.1	[4-0A]	Backup heater configuration	R/W	0: 1 1: 1/1+2 2: 1/2 3: 1/2 + 1/1+2 in emergency		
9.1	[4-0B]	Automatic cooling/heating changeover hysteresis.	R/W	1~10°C, step: 0,5°C 1°C		
9.1	[4-0D]	Automatic cooling/heating changeover offset.	R/W	1~10°C, step: 0,5°C 3°C		
9.1	[4-0E]	--		6		
9.1	[5-00]	Equilibrium: Deactivate backup heater (or external backup heat source in case of a bivalent system) above the equilibrium temperature for space heating?	R/W	0: No 1: Yes		
9.1	[5-01]	What is the equilibrium temperature for the building?	R/W	-15~35°C, step: 1°C 0°C		
9.1	[5-02]	Space heating priority.	R/W	0: OFF 1: ON		
9.1	[5-03]	Space heating priority temperature.	R/W	-15~35°C, step: 1°C 0°C		
9.1	[5-04]	Set point correction for domestic hot water temperature.	R/W	0~20°C, step: 1°C 10°C		
9.1	[5-05]	What is the requested limit for DI1?	R/W	0~50 A, step: 1 A 50 A		
9.1	[5-06]	What is the requested limit for DI2?	R/W	0~50 A, step: 1 A 50 A		
9.1	[5-07]	What is the requested limit for DI3?	R/W	0~50 A, step: 1 A 50 A		
9.1	[5-08]	What is the requested limit for DI4?	R/W	0~50 A, step: 1 A 50 A		
9.1	[5-09]	What is the requested limit for DI1?	R/W	0~20 kW, step: 0,5 kW 20 kW		
9.1	[5-0A]	What is the requested limit for DI2?	R/W	0~20 kW, step: 0,5 kW 20 kW		
9.1	[5-0B]	What is the requested limit for DI3?	R/W	0~20 kW, step: 0,5 kW 20 kW		
9.1	[5-0C]	What is the requested limit for DI4?	R/W	0~20 kW, step: 0,5 kW 20 kW		
9.1	[5-0D]	Backup heater voltage	R/W	0: 230V, 1~ 1: 230V, 3~ 2: 400V, 3~		
9.1	[5-0E]	--		1		
9.1	[6-00]	The temperature difference determining the heat pump ON temperature.	R/O	2~40°C, step: 1°C 0°C		
9.1	[6-01]	The temperature difference determining the heat pump OFF temperature.	R/W	0~10°C, step: 1°C 2°C		
9.1	[6-02]	What is the capacity of the booster heater?	R/O	0~10kW, step: 0,2kW 0kW		
9.1	[6-03]	What is the capacity of the backup heater step 1?	R/W	0~10kW, step: 0,2kW 0kW		
9.1	[6-04]	What is the capacity of the backup heater step 2?	R/W	0~10kW, step: 0,2kW 0kW		
9.1	[6-07]	--		0		
9.1	[6-08]	What is the hysteresis to be used in reheat mode?	R/W	2~20°C, step: 1°C 10°C		
9.1	[6-09]	--		0		
9.1	[6-0A]	What is the desired comfort storage temperature?	R/W	30~[6-0E]°C, step: 1°C 60°C		
9.1	[6-0B]	What is the desired eco storage temperature?	R/W	30~min(50, [6-0E])°C, step: 1°C 45°C		
9.1	[6-0C]	What is the desired reheat temperature?	R/W	30~min(50, [6-0E])°C, step: 1°C 45°C		
9.1	[6-0D]	What is the desired DHW production type?	R/W	0: Reheat only 1: Schedule + reheat 2: Schedule only		
9.1	[6-0E]	What is the maximum temperature setpoint?	R/W	E-07 = 0 40~ 60°C, step: 1°C 60°C E-07 = 3 40~ 75°C, step: 1°C 75°C E-07 = 5 40~ 80°C, step: 1°C 80°C E-07 = 7 40~ 60°C, step: 1°C 60°C E-07 = 8 40~ 75°C, step: 1°C 75°C		
9.1	[7-00]	Domestic hot water booster heater overshoot temperature.	R/W	0~4°C, step: 1°C 0°C		
9.1	[7-01]	Domestic hot water booster heater hysteresis.	R/W	2~40°C, step: 1°C 2°C		
9.1	[7-02]	How many leaving water temperature zones are there?	R/W	0: Single zone 1: Dual zone		
9.1	[7-03]	--		2,5		
9.1	[7-04]	--		0		

Field settings table					Installer setting at variance with default value	
Breadcrumb	Setting name	Range, step	Default value	Date	Value	
9.1	[7-05]	Boiler efficiency	R/W	0: Very high 1: High 2: Medium 3: Low 4: Very low		
9.1	[7-06]	HP forced OFF	R/W	0: Disabled 1: Enabled		
9.1	[7-07]	BBR16 activation* *BBR16 settings are only visible when the language of the user interface is set to Swedish.	R/W	0: No 1: Yes		
9.1	[7-09]	How much is the minimum pump PWM value.	R/W	20%		
9.1	[7-0A]	Additional zone fixed pump PWM, in case a bizona kit is installed.	R/W	20~95%, step 5% 95%		
9.1	[7-0B]	Main zone fixed pump PWM, in case a bizona kit is installed.	R/W	20~95%, step 5% 95%		
9.1	[7-0C]	Time needed by the mixing valve to turn from one side to the other, in case a bizona kit is installed.	R/W	20~300 seconds, step 5 sec 125 seconds		
9.1	[8-00]	Minimum running time for domestic hot water operation.	R/W	0~20 min, step 1 min 1 min		
9.1	[8-01]	Maximum running time for domestic hot water operation.	R/W	5~95 min, step: 5 min 30 min		
9.1	[8-02]	Anti-recycling time.	R/W	0~10 hour, step: 0,5 hour 3 hour		
9.1	[8-03]	Booster heater delay timer.	R/W	20~95 min, step: 5 min 50 min		
9.1	[8-04]	Additional running time for the maximum running time.	R/W	0~95 min, step: 5 min 95 min		
9.1	[8-05]	Allow modulation of the LWT to control the room temp?	R/W	0: No 1: Yes		
9.1	[8-06]	Leaving water temperature maximum modulation.	R/W	0~10°C, step: 1°C 5°C		
9.1	[8-07]	What is the desired comfort main LWT in cooling?	R/W	[9-03]~[9-02], step: 1°C 18°C		
9.1	[8-08]	What is the desired eco main LWT in cooling?	R/W	[9-03]~[9-02], step: 1°C 20°C		
9.1	[8-09]	What is the desired comfort main LWT in heating?	R/W	[9-01]~[9-00], step: 1°C 35°C		
9.1	[8-0A]	What is the desired eco main LWT in heating?	R/W	[9-01]~[9-00], step: 1°C 33°C		
9.1	[8-0B]	--		13		
9.1	[8-0C]	--		10		
9.1	[8-0D]	--		16		
9.1	[9-00]	What is the maximum desired LWT for main zone in heating?	R/W ([2-0C] ≠ 2) R/O ([2-0C] = 2)	[2-0C]=2: 37~70, step: 1°C 65°C [2-0C]≠2: 37~55, step: 1°C 55°C		
9.1	[9-01]	What is the minimum desired LWT for main zone in heating?	R/W	15~37°C, step: 1°C 25°C		
9.1	[9-02]	What is the maximum desired LWT for main zone in cooling?	R/W	18~22°C, step: 1°C 22°C		
9.1	[9-03]	What is the minimum desired LWT for main zone in cooling?	R/W	5~18°C, step: 1°C 5°C		
9.1	[9-04]	Leaving water temperature overshoot temperature.	R/W	1~4°C, step: 1°C 1°C		
9.1	[9-05]	What is the minimum desired LWT for add. zone in heating?	R/W	15~37°C, step: 1°C 25°C		
9.1	[9-06]	What is the maximum desired LWT for add. zone in heating?	R/W ([2-0C] ≠ 2) R/O ([2-0C] = 2)	[2-0C]=2: 37~70, step: 1°C 65°C [2-0C]≠2: 37~55, step: 1°C 55°C		
9.1	[9-07]	What is the minimum desired LWT for add. zone in cooling?	R/W	5~18°C, step: 1°C 7°C		
9.1	[9-08]	What is the maximum desired LWT for add. zone in cooling?	R/W	18~22°C, step: 1°C 22°C		
9.1	[9-09]	What is the allowed LWT undershoot during cooling start-up?	R/W	1~18°C, step: 1°C 18°C		
9.1	[9-0A]	What is the room buffering temperature in heating?	R/W	[3-07]~[3-06]°C, step: 0,5°C 23°C		
9.1	[9-0B]	What is the room buffering temperature in Cooling?	R/W	[3-09]~[3-08]°C, step: 0,5°C 23°C		
9.1	[9-0C]	Room temperature hysteresis.	R/W	1~6°C, step: 0,5°C 1 °C		
9.1	[9-0D]	Pump speed limitation	R/W	0~8, step:1 0 : No limitation 1~4 : 90~60% pump speed 5~8 : 90~60% pump speed during sampling 6 80% pump speed		
9.1	[9-0E]	--		6		
9.1	[C-00]	Domestic heating water priority.	R/O	0: Solar priority 1: Heat pump priority		
9.1	[C-01]	--		0		
9.1	[C-02]	Is an external backup heat source connected?	R/W	0: NO 1: Yes		
9.1	[C-03]	Bivalent activation temperature.	R/W	-25~25°C, step: 1°C 0°C		
9.1	[C-04]	Bivalent hysteresis temperature.	R/W	2~10°C, step 1°C 3°C		
9.1	[C-05]	What is the thermo request contact type for the main zone?	R/W	1: 1 contact 2: 2 contacts		
9.1	[C-06]	What is the thermo request contact type for the add. zone?	R/W	1: 1 contact 2: 2 contacts		

Field settings table				Installer setting at variance with default value	
Breadcrumb	Setting name	Range, step	Default value	Date	Value
9.1	[C-07]	What is the unit control method in space operation?	R/W	0: Leaving water 1: External room thermostat 2: Room thermostat	
9.1	[C-08]	Which type of external sensor is installed?	R/W	0: No 1: Outdoor 2: Room	
9.1	[C-09]	What is the required alarm output contact type?	R/W	0: Abnormal 1: Normal	
9.1	[C-0A]	--		0	
9.1	[C-0B]	--		0	
9.1	[C-0C]	--		0	
9.1	[C-0D]	--		0	
9.1	[C-0E]	--		0	
9.1	[D-00]	Which heaters are permitted if prefer. kWh rate PS is cut?	R/W	0: No 1: Only BSH 2: Only BUH 3: All	
9.1	[D-01]	Contact type of preferential kWh rate PS installation?	R/W	0: No 1: Open 2: Closed 3: Smart Grid	
9.1	[D-02]	Which type of DHW pump is installed?	R/O	0: No DHW pump 1: Instant hot water 2: Disinfection 3: Circulation 4: Circulation and disinfection	
9.1	[D-03]	Leaving water temperature compensation around 0°C.	R/W	0: No 1: increase 2°C, span 4°C 2: increase 4°C, span 4°C 3: increase 2°C, span 8°C 4: increase 4°C, span 8°C	
9.1	[D-04]	Is a demand PCB connected?	R/W	0: No 1: Pwr consmp ctrl	
9.1	[D-05]	Is the pump allowed to run if prefer. kWh rate PS is cut?	R/W	0: No 1: Yes	
9.1	[D-07]	Is a solar kit connected?	R/O	0: No 1: Yes (DHW)	
9.1	[D-08]	Is an external kWh meter used for power measurement?	R/W	0: No 1: 0,1 pulse/kWh 2: 1 pulse/kWh 3: 10 pulse/kWh 4: 100 pulse/kWh 5: 1000 pulse/kWh	
9.1	[D-09]	Is an external kWh meter used for power measurement, kWh meter used for smart grid?	R/W	0: No 1: 0,1 pulse/kWh 2: 1 pulse/kWh 3: 10 pulse/kWh 4: 100 pulse/kWh 5: 1000 pulse/kWh 6: 100 pulse/kWh (PV meter) 7: 1000 pulse/kWh (PV meter)	
9.1	[D-0A]	--		2	
9.1	[D-0B]	--		2	
9.1	[D-0C]	--		0	
9.1	[D-0D]	--		0	
9.1	[D-0E]	--		0	
9.1	[E-00]	Which type of unit is installed?	R/O	0-5 1: Minichiller	
9.1	[E-01]	Which type of compressor is installed?	R/O	0	
9.1	[E-02]	What is the indoor unit software type?	R/W (*1) R/O (*2)	0: Reversible (*1) 1: Cooling only (*2)	
9.1	[E-03]	What is the number of backup heater steps?	R/W	0: No heater 1: External heater	
9.1	[E-04]	Is the power saving function available on the outdoor unit?	R/O	0: No 1: Yes	
9.1	[E-05]	Can the system prepare domestic hot water?	R/O	0: No 1: Yes	
9.1	[E-06]	--		0	
9.1	[E-07]	What kind of DHW tank is installed?	R/O	0-8 0 OSO tank 150/180 1 FS with BUH 2 FS with BSH 3 OSO tank 200/250/300 4 Rotex without BSH (HYB) 5 Rotex with BSH 6 Third party tank for HYB 7 Third party tank, coil >= 1,05m2 8 Third party tank, coil >= 1,8m2	
9.1	[E-08]	Power saving function for outdoor unit.	R/W	0: No 1: Yes	
9.1	[E-09]	--		1	
9.1	[E-0B]	Is a bi-zone kit installed?	R/W	0: not installed 1: - 2: Bizone kit installed	
9.1	[E-0C]	What bizone kit system type is installed?	R/W	0: Without hydraulic separator / no direct pump 1: With hydraulic separator / no direct pump 2: With hydraulic separator / with direct pump	
9.1	[E-0D]	Is the system filled with glycol ?	R/W	0: No 1: Yes	
9.1	[E-0E]	--		0	
9.1	[F-00]	Pump operation allowed outside range.	R/W	0: Restricted 1: Allowed	
9.1	[F-01]	Above which outdoor temperature is cooling allowed?	R/W	10-35°C, step: 1°C 20°C	

Field settings table				Installer setting at variance with default value	
Breadcrumb	Setting name	Range, step	Default value	Date	Value
9.I	[F-02]	--	3		
9.I	[F-03]	--	5		
9.I	[F-04]	--	0		
9.I	[F-05]	--	0		
9.I	[F-09]	Pump operation during flow abnormality.	R/W	0: Disabled 1: Enabled	
9.I	[F-0A]	--	0		
9.I	[F-0B]	--	R/W	0	
9.I	[F-0C]	--	R/W	1	
9.I	[F-0D]	What is the pump operation mode?	R/W	0: Continuous 1: Sample 2: Request	
Bi-zone kit settings					
9.P.1	[E-0B]	Bi-zone kit installed	R/W	0: not installed 1: - 2: Bizone kit installed	
9.P.2	[E-0C]	Bi-zone kit system type	R/W	0: Without hydraulic separator / no direct pump 1: With hydraulic separator / no direct pump 2: With hydraulic separator / with direct pump	
9.P.3	[7-0A]	Add zone pump fixed PWM	R/W	20~95%, step 5% 95%	
9.P.4	[7-0B]	Main zone pump fixed PWM	R/W	20~95%, step 5% 95%	
9.P.5	[7-0C]	Mixing valve turning time	R/W	20~300 sec, step 5 sec 125 sec	

ERC

Copyright 2022 Daikin

DAIKIN EUROPE N.V.
Zandvoordestraat 300, B-8400 Oostende, Belgium

4P688013-1C 2023.05